



**BUILDING AMERICA®**

[Union Pacific Rules](#)

## **UPRR - General Code of Operating Rules**

**Seventh Edition**

**Effective April 1, 2020**

**Includes Updates as of April 30, 2024**

**PB-20280**

[1.0: GENERAL RESPONSIBILITIES](#)

[2.0: RAILROAD RADIO AND COMMUNICATION RULES](#)

[3.0: Section Reserved](#)

[4.0: TIMETABLES](#)

[5.0: SIGNALS AND THEIR USE](#)

[6.0: MOVEMENT OF TRAINS AND ENGINES](#)

[7.0: SWITCHING](#)

[8.0: SWITCHES](#)

[9.0: BLOCK SYSTEM RULES](#)

[10.0: RULES APPLICABLE ONLY IN CENTRALIZED TRAFFIC CONTROL \(CTC\)](#)

[11.0: RULES APPLICABLE IN ACS, ATC AND ATS TERRITORIES](#)

[12.0: RULES APPLICABLE ONLY IN AUTOMATIC TRAIN STOP SYSTEM \(ATS\) TERRITORY](#)

[13.0: RULES APPLICABLE ONLY IN AUTOMATIC CAB SIGNAL SYSTEM \(ACS\) TERRITORY](#)

[14.0: RULES APPLICABLE ONLY WITHIN TRACK WARRANT CONTROL \(TWC\) LIMITS](#)

[15.0: TRACK BULLETIN RULES](#)

[16.0: RULES APPLICABLE ONLY IN DIRECT TRAFFIC CONTROL \(DTC\) LIMITS](#)

[17.0: RULES APPLICABLE ONLY IN AUTOMATIC TRAIN CONTROL \(ATC\) TERRITORY](#)

[18.0: RULES APPLICABLE ONLY IN POSITIVE TRAIN CONTROL \(PTC\) TERRITORY](#)

[GLOSSARY: Glossary](#)

## Union Pacific Rules

### UPRR - General Code of Operating Rules

## **1.0: GENERAL RESPONSIBILITIES**

- [1.1: Safety](#)
- [1.1.1: Maintaining a Safe Course](#)
- [1.1.2: Alert and Attentive](#)
- [1.1.3: Accidents, Injuries, and Defects](#)
- [1.1.4: Condition of Equipment and Tools](#)
- [1.2: Personal Injuries and Accidents](#)
- [1.2.1: Care for Injured](#)
- [1.2.2: Witnesses](#)
- [1.2.3: Equipment Inspection](#)
- [1.2.4: Mechanical Inspection](#)
- [1.2.5: Reporting](#)
- [1.2.6: Statements](#)
- [1.2.7: Furnishing Information](#)
- [1.3: Rules](#)
- [1.3.1: Rules, Regulations, and Instructions](#)
- [1.3.2: General Orders](#)
- [1.3.3: Superintendent Bulletins, Instructions, and Notices](#)
- [1.4: Carrying out Rules and Reporting Violations](#)
- [1.4.1: Good Faith Challenge](#)
- [1.5: Drugs and Alcohol](#)
- [1.6: Conduct](#)
- [1.6.1: Motor Vehicle Driving Records](#)
- [1.6.2: Notification of Felony Convictions](#)
- [1.6.3: Notification of Deteriorating Vision or Hearing](#)
- [1.7: Altercations](#)
- [1.8: Appearance](#)
- [1.9: Railroad Company](#)
- [1.10: Games, Reading, or other Media](#)
- [1.11: Sleeping](#)
- [1.11.1: Napping](#)
- [1.12: Weapons](#)
- [1.13: Reporting and Complying with Instructions](#)
- [1.14: Employee Jurisdiction](#)
- [1.15: Duty - Reporting or Absence](#)

- [1.16: Subject to Call](#)
- [1.17: Hours of Service Law](#)
- [1.18: Unauthorized Employment](#)
- [1.19: Care of Property](#)
- [1.20: Alert to Train Movement](#)
- [1.21: Occupying Roof](#)
- [1.22: Unauthorized Persons](#)
- [1.23: Altering Equipment](#)
- [1.23.1: Locomotive-Mounted Safety Devices](#)
- [1.24: Clean Property](#)
- [1.25: Credit or Property](#)
- [1.26: Gratuities](#)
- [1.27: Divulging Information](#)
- [1.28: Fire](#)
- [1.29: Avoiding Delays](#)
- [1.30: Riding Engine](#)
- [1.31: Repairs to Foreign Cars](#)
- [1.32: Overheated Wheels](#)
- [1.33: Inspection of Freight Cars](#)
- [1.34: Flat Spots](#)
- [1.35: Dump Doors](#)
- [1.36: Excessive Dimension Loads](#)
- [1.37: Open Top Loads](#)
- [1.38: Shipments Susceptible to Damage](#)
- [1.39: Accuracy of Speed Indicator](#)
- [1.40: Reporting Engine Defects](#)
- [1.41: Engines Coupled to Occupied Passenger Cars](#)
- [1.42: Trains Detoured](#)
- [1.43: Stopped in Tunnels](#)
- [1.44: Duties of Train Dispatchers](#)
- [1.45: Duties of Control Operators and Operators](#)
- [1.46: Duties of Yardmasters](#)
- [1.47: Duties of Crew Members](#)
- [1.47.1: Cab Red Zone](#)
- [1.47.2: Training and Familiarization](#)
- [1.48: Time](#)

## **1.1: Safety**

Safety is the most important element in performing duties. Obeying the rules is essential to job safety and continued employment.

**Rule Updated Date**

April 7, 2010

[^Top](#)

### **1.1.1: Maintaining a Safe Course**

In case of doubt or uncertainty, take the safe course.

**Rule Updated Date**

April 7, 2010

[^Top](#)

### **1.1.2: Alert and Attentive**

Employees must be careful to prevent injuring themselves or others. They must be alert and attentive when performing their duties and plan their work to avoid injury.

**Rule Updated Date**

April 7, 2010

[^Top](#)

### **1.1.3: Accidents, Injuries, and Defects**

Report by the first means of communication any accidents; personal injuries; defects in tracks, bridges or signals; or any unusual condition that may affect the safe and efficient operation of the railroad. Where required, furnish a written report promptly after reporting the incident.

**Rule Updated Date**

April 7, 2010

[^Top](#)

### **1.1.4: Condition of Equipment and Tools**

Employees must check the condition of equipment and tools they use to perform their duties. Employees must not use defective equipment or tools until they are safe to use. Employees must report any defects to the proper authority.

**Rule Updated Date**

April 7, 2010

[^Top](#)

## **1.2: Personal Injuries and Accidents**

### **Rule Updated Date**

April 7, 2010

[^Top](#)

### **1.2.1: Care for Injured**

When passengers or employees are injured, do everything reasonable to care for them.

### **Rule Updated Date**

April 7, 2010

[^Top](#)

### **1.2.2: Witnesses**

If equipment is involved in personal injury, loss of life, or damage to property, the employee in charge must immediately secure the names, addresses and occupations of all persons involved, including all persons at the scene when the accident occurred and those that arrived soon after. The employee in charge must secure the names regardless of whether these persons admit knowing anything about the accident.

The employee in charge must also obtain the license number of nearby automobiles. When necessary, other employees can assist in obtaining this information, which must be included in reports covering the incident.

Where signaling devices are provided or a flagman is on duty, the employee in charge and assisting employees must try to determine whom, among the witnesses, can testify whether the signaling devices were functioning properly or if the flagman was performing his duties properly.

### **Rule Updated Date**

April 7, 2010

[^Top](#)

### **1.2.3: Equipment Inspection**

If an accident results in personal injury or death, all tools, machinery, and other equipment involved, including the accident site, must be inspected promptly by the foreman, another person in charge of the work, or other competent inspectors. The inspector must promptly forward to his manager a report of the inspection. The report must include the condition of the equipment and the names of those making the inspection.

The equipment inspected must be marked for identification and placed in custody of the responsible manager or employee until the claims department is contacted and determines disposition.

**Rule Updated Date**

April 7, 2010

[^Top](#)

### **1.2.4: Mechanical Inspection**

When engines, cars or other equipment are involved in an accident that results in personal injury or death, the equipment must be inspected before it leaves the accident site.

A mechanical department employee must further inspect the equipment at the first terminal. This employee must promptly report inspection results to the proper manager.

**Rule Updated Date**

April 7, 2010

[^Top](#)

### **1.2.5: Reporting**

All cases of personal injury, while on duty or on company property, must be accurately, timely, and immediately reported to the proper manager. For injuries that result in medical evaluation and/or treatment from an outside provider, the injured employee must complete Form 52032 (Rev. 07/19).

A personal injury that occurs while off duty that will in any way affect employee performance of duties must be reported to the proper manager as soon as possible. The injured employee must complete Form 52032 (Rev. 07/19) before returning to service.

All cases of occupational illnesses must be immediately reported to the proper manager and Form 52032 (Rev. 07/19) must be completed by the employee.

Because railroads are required by Federal Regulations to report injuries and occupational illnesses that meet certain medical treatment criteria, when medical treatment is received from an outside provider, employees must report to the proper manager medical treatment they receive that is directly related to their injury or illness, including follow-up visits. Below are some examples of the types of medical treatments and instructions employees must report to the proper manager, if provided, in relation to an injury or occupational illness:

- Medical treatment provided or recommended
- Physical therapy or chiropractic treatments
- Prescriptions and other medications issued or recommended, including dosages
- Lost work day instructions
- Work restriction instructions

**Application:**

Reporting: "Proper manager" is defined as the employee's assigned manager, or any on duty manager for work group. While employees are encouraged to immediately seek first aid or medical treatment when needed, consulting with, or being seen by an Occupational Health Nurse (OHN) does not relieve the employee of reporting requirements. Form 52023 (Rev. 07/19) must be filled out by the employee in the presence of a Union Pacific Manager.

\*\*Outdated revisions of Form 52032 will not be accepted, in order to provide Safety Reporting Compliance with all necessary information to meet regulatory requirements.

**Rule Updated Date**

July 11, 2023

**System Special Instructions**

Effective Date: July 11, 2023

[^Top](#)

**1.2.6: Statements**

Except when authorized by the proper manager:

- Information concerning accidents or personal injuries that occur to persons other than employees may be given only to an authorized representative of the railroad or an officer of the law.
- Information about the facts concerning the injury or death of an employee may be given only to a person in interest such as the injured employee, an immediate relative of the injured or deceased employee, an authorized representative of the railroad, or an officer of the law.
- Information in the files or in other privileged or confidential reports of the railroad concerning accidents or personal injuries may be given only to an authorized representative of the railroad.

**Rule Updated Date**

April 7, 2010

[^Top](#)

**1.2.7: Furnishing Information**

Employees must not withhold information, or fail to give all the facts to those authorized to receive information regarding unusual events, accidents, personal injuries, or rule violation.

**Rule Updated Date**

April 7, 2010

[^Top](#)

## 1.3: Rules

### Rule Updated Date

April 7, 2010

[^Top](#)

### 1.3.1: Rules, Regulations, and Instructions

**Safety Rules.** Employees must have a copy of, be familiar with, and comply with all safety rules issued in a separate book or in another form.

**General Code of Operating Rules.** Employees governed by these rules must have a current copy they can refer to while on duty.

**Hazardous Materials.** Employees who in any way handle hazardous materials must have a copy of the instructions or regulations for handling these materials. Employees must be familiar with and comply with these instructions or regulations.

**Air Brakes.** Employees whose duties are affected by air brake operation must have a copy of the files and instructions for operating air brakes and train handling. Employees must know and obey these rules and instructions.

**Timetable and Special Instructions.** Employees whose duties are affected by the timetable and special instructions must have a current copy they can refer to while on duty.

**Train Dispatchers and Control Operators.** The train dispatchers and control operators must have a copy of rules and instructions for train dispatchers and control operators. They must be familiar with and obey those rules and instructions.

**Rules, Regulations and Instructions.** Employees must be familiar with and obey all rules, regulations, and instructions and must complete required courses. Employees must pass examinations to check their knowledge of the rules, regulations and instructions as required.

**Explanation.** Employees must ask their supervisor for an explanation of any rule, regulation, or instruction they are unsure of.

**Issued, Canceled, or Modified.** Rules may be issued, canceled, or modified by track bulletin, general order or special instructions. When there is a conflict, subdivision special instructions take precedence over system special instructions.

### Rule Updated Date

June 1, 2018

### System Special Instructions

Effective Date: June 1, 2018

[^Top](#)

### 1.3.2: General Orders

General Orders:



- Are numbered consecutively.
- Are issued and cancelled by the designated manager.
- Contain only information and instructions related to rules or operating practices.
- Replace any rule, special instruction, or regulation that conflicts with the general order.

Before beginning each day's work or trip, crew members and any others whose duties require, must review general orders that apply to the territory they will work on. Employees must each have a current copy of system general orders and subdivision general orders they can refer to while on duty.

**Rule Updated Date**

April 1, 2015

**System Special Instructions**

Effective Date: April 1, 2015

[^Top](#)

### **1.3.3: Superintendent Bulletins, Instructions, and Notices**

Superintendent bulletins, instructions, notices, and other information are issued and canceled by the designated manager. Before beginning each day's work or trip, crew members and any others whose duties require, must review those that apply to the territory they will work on.

**Rule Updated Date**

June 1, 2017

**System Special Instructions**

Effective Date: June 1, 2017

[^Top](#)

### **1.4: Carrying out Rules and Reporting Violations**

Employees must cooperate and assist in carrying out the rules and instructions. They must promptly report any violations to the proper supervisor. They must also report any condition or practice that may threaten the safety of trains, passengers, or employees, and any misconduct or negligence that may affect the interest of the railroad.

**Rule Updated Date**

April 7, 2010

[^Top](#)

## **1.4.1: Good Faith Challenge**

### **A. Right to Challenge**

Federal Regulations have provisions that allow an employee the right to challenge a directive which, based upon the employee's good faith determination, would violate a railroad operating rule relating to:

- Shoving movements.
- Leaving equipment foul of an adjacent track.  
or
- Handling of hand-operated switches or fixed derails.

### **B. Good Faith Challenge Procedure**

1. An employee may inform a supervisor issuing a directive that a good faith determination has been made that the directive would violate a railroad operating rule relating to:

- Shoving movements.
- Leaving equipment foul of an adjacent track.  
or
- Handling of hand-operated switches or fixed derails.

2. The supervisor will not require the employee to comply with the directive until the challenge is resolved. The supervisor may:

- Require the challenging employee to perform other tasks not related to the challenge until the challenge is resolved.  
or
- Direct an employee, other than the challenging employee, to perform the challenged task before the challenge is resolved. Employee so directed will be informed of the challenge, and determine that the challenged task does not violate the rules.

### **C. Resolving Good Faith Challenge**

1. A challenge may be resolved by one of the following:

- The supervisor's acceptance of the employee's request.
- An employee's acceptance of the directive.
- An employee's agreement to a compromise solution acceptable to the person issuing the directive.

2. If the challenge cannot be resolved because the supervisor issuing the directive has determined that the employee's challenge has not been made in good faith or there is no alternative to the direct order, the railroad will:

- Provide immediate review by at least one manager, which must not be conducted by the supervisor issuing the challenged directive or that supervisor's subordinate.
- Resolve the challenge using the same options available for resolving the challenge as the initial supervisor.

3. If the manager making the final decision concludes that the challenged directive would not cause the employee to violate any requirement of the involved rules, the reviewing manager's decision shall be final and not subject to further immediate review.

- The manager will inform the employee that Federal law may protect the employee from retaliation, if the employee's refusal to do the work is a lawful, good faith act.
- The employee making the challenge will be afforded an opportunity to document, in writing or electronically, any protest to the manager making the final decision before the employee's tour of duty is complete. The employee will be afforded the opportunity to retain a copy of the protest.

#### **D. Request for Review and Verification of Decision**

Upon written request, at the time of the challenge, the employee has the right for further review by the Designated Review Manager. Within 30 days after the expiration of the month during which the challenge occurred, the Designated Review Manager will verify the proper application of the rule in question. The verification decision shall be made in writing to the employee.

#### **E. Employee Rights and Remedies**

The Good Faith Challenge is not intended to abridge any rights or remedies available to the employee under a collective bargaining agreement or any Federal law.

#### **Rule Updated Date**

April 7, 2010

[^Top](#)

## **1.5: Drugs and Alcohol**

The use or possession of alcoholic beverages while on duty or on company property is prohibited. Employees must not have any measurable alcohol in their breath or in the bodily fluids when reporting for duty, while on duty or while on company property.

The use or possession of intoxicants, over-the-counter or prescription drugs, narcotics, controlled substances, or medication that may adversely affect safe performance is prohibited while on duty or on company property, except medication that is permitted by a medical practitioner and used as prescribed. Employees must not have any prohibited substances in their bodily fluids when reporting for duty, while on duty, or while on company property.

Refusals to provide a test sample or interference or delay in the testing process are also treated as prohibited conduct. This also includes leaving the scene of an accident, tampering or substituting a sample.

#### **Application:**

Also refer to the UPRR Drug and Alcohol Policy which governs all employees. Access the policy by using the link:

[http://home.www.uprr.com/emp/operating/op\\_prac/dap/index.shtml](http://home.www.uprr.com/emp/operating/op_prac/dap/index.shtml)

#### **Rule Updated Date**

May 2, 2016

#### **System Special Instructions**

Effective Date: May 2, 2016

[^Top](#)

## **1.6: Conduct**

Employees must not be:

1. Careless of the safety of themselves or others
2. Negligent
3. Insubordinate
4. Dishonest
5. Immoral
6. Quarrelsome
- or
7. Discourteous

Any act of hostility, misconduct, or willful disregard or negligence affecting the interest of the company or its employees is cause for dismissal and must be reported. Indifference to duty or to the performance of duty will not be tolerated.

### **Rule Updated Date**

April 7, 2010

[^Top](#)

### **1.6.1: Motor Vehicle Driving Records**

A certified conductor, engineer, employee seeking initial certification or employees qualified to drive commercial motor vehicles must report any arrest, citation or conviction to an employee assistance representative at (800)779-1212, within 48 hours for:

- Operating a motor vehicle while under the influence of or impaired by alcohol or a controlled substance.
- Refusal to undergo such testing when a law enforcement official seeks to find out whether a person is operating under the influence of alcohol or a controlled substance.

State-sponsored diversion programs, guilty pleas, and completed state actions to cancel, revoke, suspend, or deny a driver's license are considered convictions as applied to this rule.

### **Rule Updated Date**

April 1, 2015

### **System Special Instructions**

Effective Date: April 1, 2015

[^Top](#)

## **1.6.2: Notification of Felony Convictions**

The conduct of any employee leading to conviction of any felony is prohibited. Any employee convicted of a felony must notify the proper authority of that fact within 48 hours after the employee receives notice of the conviction.

### **Rule Updated Date**

April 7, 2010

[^Top](#)

## **1.6.3: Notification of Deteriorating Vision or Hearing**

A certified conductor, engineer or employee seeking initial certification who has knowledge that their hearing or vision has deteriorated and cannot be corrected to the minimum acceptable requirement as outlined in federal regulations (20/40 distant visual acuity, 70 degree field of vision, ability to recognize/distinguish between railroad color signals, hearing loss no greater than 40 decibels) must report that fact immediately to the proper authority or the medical department.

Note: A certified conductor, engineer or employee seeking initial certification who has knowledge that a restriction listed on their FRA Certificate has been corrected or improved to meet the minimum acceptable requirement as outlined in federal regulations must report that fact immediately to the proper authority or the medical department (402-544-5234).

### **Rule Updated Date**

April 1, 2015

### **System Special Instructions**

Effective Date: April 1, 2015

[^Top](#)

## **1.7: Altercations**

Employees must not enter into altercations with each other, play practical jokes, or wrestle while on duty or on railroad property.

### **Rule Updated Date**

April 7, 2010

[^Top](#)

## **1.8: Appearance**

Employees reporting for duty must be clean and neat. They must wear the prescribed uniform when required.

**Rule Updated Date**

April 7, 2010

[^Top](#)

**1.9: Railroad Company**

Employees must behave in such a way that the railroad will not be criticized for their actions.

**Rule Updated Date**

April 7, 2010

[^Top](#)

**1.10: Games, Reading, or other Media**

Employees on duty must not:

- Play games.
- Use personal electronic devices other than provided for in Rule 2.21 (Electronic Devices).  
or
- Read magazines, newspapers, or other literature not related to their duties when:
  - It would delay or interfere with required duties.
  - Performing safety related activities.
  - A member of a train crew is performing safety related activities.or
- Any other authorized individual is assisting in preparation of the train, engine or on-track equipment for movement.

All literature and electronic devices not related to assigned duties must be properly stowed when required.

**Rule Updated Date**

January 7, 2019

**System Special Instructions**

Effective Date: January 7, 2019

[^Top](#)

**1.11: Sleeping**

Employees must not sleep while on duty, except as outlined under Rule 1.11.1(Napping). Employees reclined with their eyes closed will be in violation of this rule.

## Rule Updated Date

April 7, 2010

[^Top](#)

### 1.11.1: Napping

**TE&Y and Engineering employees, except those working in passenger or commuter service are permitted to nap while on duty when it does not cause a delay to the operations or interfere with the performance of safety-related duties, the safety of the employee, coworkers, or the public under the following conditions:**

- The employee has reported on duty and completed all necessary preparations for duty including a job briefing. These duties include reviewing all general orders, track warrants, track bulletins, and all other paperwork.
- The employee responsible for notifying a napping employee work is ready to proceed should allow at least 15 minutes for the napping employee to recover from grogginess which may occur after awaking. Another job briefing must not occur during the 15 minute recovery period, but must take place prior to proceeding with work to ensure all employees are prepared to perform service after the operational delay has concluded.
- The napping employee is relieved of all duties during the napping period. Employees being transported to or from their job duties may nap when no safety sensitive duties are being performed by another employee.

#### **Transportation Employee Requirements:**

- When napping in a designated napping facility, one member of the assigned crew or work team must remain awake at all times to perform any work related duties including ensuring that all employees are ready to commence work promptly after the delay has ended. If the entire crew requests time to nap, the supervisor on duty may grant the request if doing so does not jeopardize the safety of the employees, the public, or train operations and will be responsible for ensuring the crew is ready to commence work promptly after the delay has ended.
- A job briefing must be conducted to review the conditions of the napping period and to reach agreement as to who will nap and who must remain awake. The employee's supervisor or co-worker has the right and responsibility to refuse to allow another employee to take a nap if doing so could jeopardize safety or cause undue delay to operations.
- Before napping is allowed **on a locomotive:**
  1. The employee in charge of the locomotive controls must:
    - Make at least a 10 pound brake pipe reduction.
    - Place generator field switch in the "OFF" position.
    - Center and remove the reverser, if removable.
  2. The employee who is to remain awake must remain on the locomotive while others on the locomotive are napping, except when inspecting passing trains.

#### **Engineering Employee Requirements:**

- Employee must request a nap from their immediate supervisor and identify the location where the nap is to take place. The supervisor may grant the request if doing so does not jeopardize the safety of employees, the public or train operations. In no case may the employee nap foul of any track or in an area where equipment is operating.
- Before napping is allowed **on maintenance of way equipment:** The operator of the equipment must ensure the equipment is properly tied down, secured against movement and adequately ventilated.
- When on a road in a company vehicle, at least one employee in addition to the employee driving the vehicle must stay awake to help the driver identify potential hazards ahead.

**Rule Updated Date**

May 2, 2016

**System Special Instructions**

Effective Date: May 2, 2016

[^Top](#)

## **1.12: Weapons**

While on duty or on railroad property, employees must not have firearms or other deadly weapons, including knives with a blade longer than 3 inches. However, railroad police are authorized to possess firearms in the course of their work.

**Application:**

Also refer to UPRR Policy to Address Violence & Abusive Behavior in the Work Place. Access the policy by using the link: <http://home.www.uprr.com/emp/ec/policy/violence.shtml>

**Rule Updated Date**

April 1, 2015

**System Special Instructions**

Effective Date: April 1, 2015

[^Top](#)

## **1.13: Reporting and Complying with Instructions**

Employees will report to and comply with instructions from supervisors who have the proper jurisdiction. Employees will comply with instructions issued by managers of various departments when the instructions apply to their duties.

**Rule Updated Date**

April 7, 2010



[^Top](#)

## **1.14: Employee Jurisdiction**

Employees are under the jurisdiction of the supervisors of the railroad they are operating on. When operating on another railroad, unless otherwise instructed, employees will be governed by:

- Safety rules, air brake and train handling rules and hazardous materials instructions of the railroad they are employed by.
- The operating rules, timetable and special instructions of the railroad they are operating on.

### **Rule Updated Date**

April 7, 2010

[^Top](#)

## **1.15: Duty - Reporting or Absence**

Employees must report for duty at the designated time and place with the necessary equipment to perform their duties. They must spend their time on duty working only for the railroad. Employees must not leave their assignment, exchange duties, or allow others to fill their assignment without proper authority.

Continued failure by employees to protect their employment will be cause for dismissal.

### **Rule Updated Date**

April 7, 2010

[^Top](#)

## **1.16: Subject to Call**

Employees subject to call must indicate where they can be reached and must not be absent from their calling place without notifying those required to call them.

### **Rule Updated Date**

April 7, 2010

[^Top](#)

## **1.17: Hours of Service Law**

Employees must be familiar and comply with the requirements of the federal hours of service law, including accurate reporting. Employees are expected to use off-duty time so they are prepared for work.

If an employee is called to report for duty before legal off-duty time has expired, before accepting the call to work the employee must notify the individual making the call that off-duty time has not expired.

### **A. Notification**

When communication is available, employees must notify the train dispatcher or another authority of the time the law requires them to be off duty. Employees must provide notification early enough that they may be relieved, or transportation provided, before they exceed the hours of service.

### **B. Exceeding the Law**

Employees must not exceed the hours of service law without proper authority. However, they must not leave trains, engines, or cars on the main track without proper protection. Employees must secure trains properly and, if possible, before they exceed the hours of service. Except as provided by this paragraph, employees are then relieved of all duties.

#### **Rule Updated Date**

October 10, 2017

#### **System Special Instructions**

Effective Date: June 1, 2018

[^Top](#)

## **1.18: Unauthorized Employment**

Employees must not engage in another business or occupation that would create a conflict of interest with their employment on the railroad or would interfere with their availability for service or the proper performance of their duties.

#### **Rule Updated Date**

April 7, 2010

[^Top](#)

## **1.19: Care of Property**

Employees are responsible for properly using and caring for railroad property. Employees must return the property when the proper authority requests them to do so. Employees must not use railroad property for their personal use.

#### **Rule Updated Date**

April 7, 2010

[^Top](#)

## **1.20: Alert to Train Movement**

Employees must expect the movement of trains, engines, cars or other movable equipment at any time, on any track and in either direction.

Employees must not stand on the track in front of an approaching engine, car or other moving equipment.

Employees must be aware of the location of structures or obstructions where clearances are close.

**Rule Updated Date**

April 7, 2010

[^Top](#)

## **1.21: Occupying Roof**

Employees whose duties require them to occupy the roof of a car or engine must do so only with proper authority and when the equipment is standing.

**Rule Updated Date**

April 7, 2010

[^Top](#)

## **1.22: Unauthorized Persons**

Unauthorized persons or trespassers on company property must be told to leave the premises, unless confronting the person(s) would be unsafe.

If the person(s) refuse to leave, or if confronting the person(s) would be unsafe, request immediate assistance from Railroad Police (RMCC) or local law enforcement authorities.

Promptly notify the train dispatcher or supervisor when unauthorized persons or emergency responders are observed on, under or between railroad equipment.

When made aware of emergency responders on, under or between railroad equipment, train dispatcher or supervisor must arrange for a qualified employee to inspect all affected equipment to verify proper securement as soon as practical.

When possible, Railroad Police must be advised of all unauthorized persons or trespassers on company property.

**Rule Updated Date**

January 7, 2019

**System Special Instructions**

Effective Date: May 10, 2019

[^Top](#)

## **1.23: Altering Equipment**

Without proper authority, employees must not alter, nullify, change the design of, or in any manner restrict or interfere with the normal function of any device or equipment on engines, cars, or other railroad property, except in the case of an emergency. Employees must report to the proper supervisor changes made in an emergency.

### **Rule Updated Date**

April 7, 2010

[^Top](#)

## **1.23.1: Locomotive-Mounted Safety Devices**

### **A. Tampering with or Disabling**

Employees are prohibited from:

- Tampering with or disabling any locomotive mounted safety device.
- Operating or failing to take appropriate action to prevent a train from being operated when the controlling locomotive of that train is equipped with a disabled safety device, except as provided in part C of this rule.

Safety devices include crew alertness devices, automatic cab signal devices, automatic train control devices, PTC system, and audio, video and other recording devices concerning operations.

### **B. Inspection of Locomotive-Mounted Safety Devices**

The engineer must make a visual inspection of accessible safety devices in the controlling locomotive cab, nose or vestibule, or in the cab control car when taking charge of a locomotive or train to ensure that:

- Nothing interferes with their intended function.
- Switches and breakers controlling the devices are in proper position.
- Seals, as appropriate, are properly applied.
- There is no apparent damage to the device.

If any exceptions are detected, immediately report them to the train dispatcher.

### **C. Operation of Trains with Defective or Disabled Locomotive-mounted Safety Devices**

Locomotives or cab control cars with defective or disabled safety devices must not be operated as the controlling unit unless:

- Provided for in the operating rules,  
or
- Authorized by the train dispatcher.

### **Rule Updated Date**

May 10, 2022

## **System Special Instructions**

Effective Date: May 10, 2022

[^Top](#)

### **1.24: Clean Property**

Railroad property must be kept in a clean, orderly, and safe condition. Railroad buildings, facilities, or equipment must not be damaged or defaced. Only information authorized by the proper manager or required by law may be posted on railroad property.

#### **Rule Updated Date**

April 7, 2010

[^Top](#)

### **1.25: Credit or Property**

Unless specifically authorized, employees must not use the railroad's credit and must not receive or pay out money on the railroad account. Employees must not sell or in any way get rid of railroad property without proper authority. Employees must care for all articles of value found on railroad property and promptly report the articles to the proper authority.

#### **Rule Updated Date**

April 7, 2010

[^Top](#)

### **1.26: Gratuities**

Employees must not discriminate among railroad customers. Employees must not accept gifts or rewards from customers, suppliers, or contractors of the railroad unless authorized by the proper authority.

#### **Rule Updated Date**

April 7, 2010

[^Top](#)

### **1.27: Divulging Information**

Employees who make up, handle, or care for any of the following must not allow an unauthorized person to access them or disclose any information contained in them:

- Correspondence

- Reports
- Books
- Bills of lading
- Waybills
- Tickets
- Statistics

Employees are responsible for all activity with their assigned User ID's and are responsible for protecting the confidentiality of information accessed. Sharing passwords is prohibited. Unauthorized use of another person's User ID and password is prohibited.

**Rule Updated Date**

April 1, 2015

**System Special Instructions**

Effective Date: April 1, 2015

[^Top](#)

**1.28: Fire**

Employees must take every precaution to prevent loss and damage by fire.

Employees must report promptly to the train dispatcher any fires seen on or near the right of way, unless the fires are being controlled. If there is danger of the fire spreading to a bridge or other structure, crew members must stop their train and help extinguish the fire.

Cause of fire, if known, must be promptly reported.

**Rule Updated Date**

April 7, 2010

[^Top](#)

**1.29: Avoiding Delays**

Crew members must operate trains and engines safely and efficiently. All employees must avoid unnecessary delays.

When possible, train or engine crews wanting to stop the train to eat must ask the train dispatcher at least one hour and thirty minutes before the desired stop.

**Rule Updated Date**

April 7, 2010

[^Top](#)

### **1.30: Riding Engine**

When possible, crew members on the head end of freight trains must ride in the control compartment of the engine.

When riding on the head end, the conductor will ride in the control compartment.

#### **Rule Updated Date**

April 7, 2010

[^Top](#)

### **1.31: Repairs to Foreign Cars**

Crew members who repair foreign cars must report the repairs on the prescribed form.

#### **Rule Updated Date**

April 7, 2010

[^Top](#)

### **1.32: Overheated Wheels**

When overheated wheels are found on a train, the train must be stopped and held a minimum of 10 minutes to allow the heat to equalize through the wheel.

#### **Rule Updated Date**

April 7, 2010

[^Top](#)

### **1.33: Inspection of Freight Cars**

When personnel are not on duty primarily to inspect freight cars, each car placed in the train may be moved after it receives a safety inspection as follows:

- Cars must be checked for:
  - Leaning.
  - Sagging.
  - Improper position on the truck.
  - Objects hanging or dragging from the car or extending from the side.

- Insecurely attached doors.
- Broken or missing safety appliances.
- Contents leaking from placarded hazardous material car.
- Insecure coupling device.
- Overheated wheel or journal.
- Broken or cracked wheel.
- Brake that fails to release.
- Staff type brake not in fully raised position.
- Any apparent hazard that could cause an accident

- Open top loads, including trailers and containers on flat cars, must be loaded safely.
- If width or height approaches clearance restrictions, movement must be cleared with the proper authority.

A freight car with any defect that makes movement unsafe must be corrected or set out of the train. When a defect is discovered enroute, note the type of defect on proper tag and attach a tag on each side of the car.

A freight car with three bad order tags indicating that the car is safe to move may be moved to the nearest car repair point. A crew member will remove one bad order tag from the side with two tags. The crew member who removed the tag will use the written information from the tag to inform other crew members of the restrictions.

**Application:**

1. When a defect is discovered, note the type of defect on proper tag and attach a tag on each side of the car.
2. Open top rail equipment loaded with wood chips or bark must be covered with approved netting.
3. When applicable, inspections required by Hazardous Materials Instructions must be completed.

**Rule Updated Date**

May 10, 2022

**System Special Instructions**

Effective Date: May 10, 2022

[^Top](#)

### **1.34: Flat Spots**

If a wheel on a piece of equipment has a flat spot more than 2-1/2 inches long, or if the wheel has adjoining flat spots that are each at least 2 inches long, the equipment must not be moved faster than 10 MPH. Such equipment in a train must be set out at the first available point.

**Rule Updated Date**

April 7, 2010

[^Top](#)



## **1.35: Dump Doors**

Be sure dump doors on cars are closed after a load is dumped. If cars must be moved short distances with the dump doors open, make sure the doors and chains will clear tracks and crossings.

### **Rule Updated Date**

April 7, 2010

[^Top](#)

## **1.36: Excessive Dimension Loads**

Place excessive dimension loads on or near the head end of trains.

Instructions will be issued to trains handling excessive dimension loads. If no instructions have been issued regarding handling the car, the conductor will immediately notify the train dispatcher.

Crew members handling excessive dimension equipment must ensure that the equipment will clear nearby objects, including equipment on adjacent tracks. If the train cannot reach a point with enough clearance, crew members must make sure protection is provided against movements on adjacent tracks.

### **Rule Updated Date**

April 7, 2010

[^Top](#)

## **1.37: Open Top Loads**

Flat cars, open top cars, and open top TOFCs/COFCs with loads that are likely to shift must not be placed in trains next to the following if train length and makeup permit:

- Occupied outfit car
- Passenger car
- Occupied locomotive or occupied caboose.
- Shipment of automotive vehicles and machinery that is not fully enclosed

This restriction does not apply to cars with permanent tie-downs.

### **Rule Updated Date**

April 1, 2015

### **System Special Instructions**

Effective Date: April 1, 2015

[^Top](#)

### **1.38: Shipments Susceptible to Damage**

Shipments with painted or finished surfaces susceptible to damage, such as automobiles, trucks, tractors, combines, and other similar equipment or machinery, must not be placed closer than the fifth car behind open top cars loaded with commodities such as coal, sand, gravel, lime, soda ash, etc. subject to wind, vapor or fume action on adjacent cars. Exceptions include shipments susceptible to damage that are:

- Loaded in cars that fully enclose the shipments.  
or
- Fully protected by a covering.

An open top car loaded with sand, gravel, lime, soda ash, etc., subject to wind, vapor, or fume action in other than a solid unit train must not be placed immediately ahead of an occupied caboose.

#### **Rule Updated Date**

April 7, 2010

[^Top](#)

### **1.39: Accuracy of Speed Indicator**

The engineer must verify speed indicator accuracy as soon as possible after taking charge of the engine. If the speed indicator is not accurate to within 3 MPH plus or minus at speeds of 10 to 30 MPH and to within 5 MPH plus or minus at speeds above 30 MPH, the engineer must immediately report the variance to the train dispatcher.

#### **Rule Updated Date**

April 7, 2010

[^Top](#)

### **1.40: Reporting Engine Defects**

The engineer will report any engine defect on the proper form and notify the relieving engineer, when needed.

#### **Rule Updated Date**

April 7, 2010

[^Top](#)

### **1.41: Engines Coupled to Occupied Passenger Cars**

Engines coupled to equipment that includes occupied passenger cars must not be left without an authorized employee in charge.

**Rule Updated Date**

April 7, 2010

[^Top](#)

## **1.42: Trains Detoured**

When trains are detoured over another railroad, the engineer of the detoured train will operate the engine, unless otherwise approved by a manager of the railroad the train is being detoured over.

The pilot will inform the engineer of speed restrictions, signals, sidings, etc. to make sure the train detours over the railroad safely.

**Rule Updated Date**

April 7, 2010

[^Top](#)

## **1.43: Stopped in Tunnels**

### **A. Engine or Train Stopped in Tunnel**

When an engine is stopped in a tunnel and cannot move promptly, crew members must:

- 1 Shut down diesel engine at once.
- 2 Shut down Waukesha or similar type engine.
- 3 Make a full service air brake application.
- 4 Apply hand brakes to prevent movement in case the air brakes leak off.
- 

### **B. Passenger Train Stopped in Tunnel or Deep Snow**

Crew members of a passenger train stopped in a tunnel or deep snow must:

1. Shut off any air circulating systems including:
  - a Air conditioning
  - b Ice Machines
  - c Generators
  -
2. Shut air intake shutters.
3. Turn off blower fans.

### **C. Notification if Stopped in Tunnel or Deep Snow**

The train dispatcher should be notified immediately so that proper arrangements can be made to protect persons and equipment.

### **D. When These Requirements Will Not Apply**

These requirements will not apply if air currents carry the exhaust gases away from the train. Safety of passengers and crew members must be the first consideration.

#### **Rule Updated Date**

April 7, 2010

[^Top](#)

## **1.44: Duties of Train Dispatchers**

Train dispatchers supervise train movement and any employees connected with that movement.

#### **Rule Updated Date**

April 7, 2010

[^Top](#)

## **1.45: Duties of Control Operators and Operators**

Control Operators and operators are under the direction of the train dispatcher when their duties concern handling track warrants, track bulletins, lineups, the movement of trains, and any other instructions issued by the train dispatcher.

#### **Rule Updated Date**

April 7, 2010

[^Top](#)

## **1.46: Duties of Yardmasters**

The yardmaster is responsible for and shall directly supervise yard crews, clerks, and all other employees working in the yard. The yardmaster must see that they work in a safe, efficient, and economical manner, according to the rules, regulations, and instructions of the railroad. Yardmasters must ensure the prompt and regular movement of cars, especially the proper makeup of trains and their movement into and out of the yard.

At locations where yardmasters are on duty, employees in train, engine, and yard service must comply with the yardmaster's instructions. At locations where no yardmaster is on duty, these employees will work according to the instructions of designated employees.

#### **Rule Updated Date**

April 7, 2010

[^Top](#)

## **1.47: Duties of Crew Members**

The conductor and the engineer are responsible for the safety and protection of their train and observance of the rules. They must ensure that their subordinates are familiar with their duties, determine the extent of their experience and knowledge of the rules, and instruct them, when necessary, on how to perform their work properly and safely. If any conditions are not covered by the rules, they must take precautions to provide protection.

When the conductor is not present, other crew members must obey the instructions of the engineer concerning rules, safety, and protection of the train.

### **A. Conductor Responsibilities**

#### **1. Supervises the Operation**

The conductor supervises the operation and administration of the train (if trains are combined with more than one conductor on board, the conductor with the most seniority takes charge). All persons employed on the train must obey the conductor's instructions, unless the instructions endanger the train's safety or violate the rules. If any doubts arise concerning the authority for proceeding or safety, the conductor must consult with the engineer who will be equally responsible for the safety and proper handling of the train.

#### **2. Restrictions on Equipment**

The conductor must advise the engineer and train dispatcher of any restriction placed on equipment being handled.

#### **3. Calling Attention to Restrictions**

The conductor must remind the engineer that the train is approaching an area restricted by:

- Limits of authority.
- Track warrant.
- Radio speed restriction.
- or
- Track bulletin.

The conductor must inform the engineer after the train passes the last station, but at least 2 miles from the restriction.

#### **4. Freight Conductors**

Freight conductors are responsible for the freight carried by their train. They are also responsible for ensuring that the freight is delivered with any accompanying documents to its destination or terminals. Freight conductors must maintain any required records.

#### **5. Conductor Report Form**

UPRR crews operating on a foreign railroad are required to properly complete a UPRR form or a foreign railroad form as required by UPRR rules. Foreign railroad crews operating on the UPRR are governed by that railroad's rule concerning awareness forms.

"Conductor Report Form" (FORM 20849) must be maintained as follows(**also see Item 10-K**):

a. Road freight conductors, including locals and switchers but not including yard or passenger conductors, are required to complete the Conductors Report. However, yard conductors performing road service on the main track (transfer, relief service, etc.) will be required to complete the Conductors Report Form.

Remote control operators are not required to maintain a Conductor Report Form except when required by Item 10-K.

The report will include:

- The name of other than Clear wayside signals, speed of the train as head end passes and, as appropriate, a "Z" or "X".
- After passing an Approach or Diverging Approach signal the next wayside signal must be entered regardless of signal indication including the speed of the train (even if the signal is Clear).
- Train defect detector results from all detectors (except "%" detectors) and mile post. "X" will identify in cab communication of results.
- Approaching temporary speed restrictions that affect the train. (Enter speed of restriction on form).
- Approaching the end of authority unless additional authority has been granted to continue on the main track. If the additional authority contains a Box 2 (after arrival) it must be included on the form.
- Train delays.
- Restricted Speed documentation. Every 2 miles that the train is operating at Restricted Speed, enter mile post location, time, train speed, a "Z" to indicate that the information was communicated between crew members and amount of air brake application if any, (None, Minimum, 10#, etc.).
- On the main track in non-signaled territory, the time, train's milepost location, and speed every 5 miles and record an "X" to indicate the information was communicated between crew members. (Comply with bullet 7 if operating at Restricted Speed).
- On Subdivisions with a "CG" location (as listed in SSI Item 8), record the time and speed of the train as the train crests the grade. Enter an "X" to indicate the information was communicated between crew members.

Entries will be made when head end of train is at or about the mile post location of required entry. Entries will be sequential and legible.

**EXAMPLES:**

LOCATION	SIGNAL NAME OR TDD ANNOUNCEMENT	TIME	COMMENTS & DELAYS
87.3	AA	0535	X - 52 MPH
89.1	A	0543	Z - 33 MPH
Y091	S	0558	X - Stop - 8" delay
92.5	RP	0617	Z - 12 MPH
94.5	RS	0625	Z - 8 MPH - None
101.3	TSR	0643	Z - 30 MPH
103.3	ND	0657	X
115.0	XH	0715	Z - 15 MPH

129.0		0755	PU - 8 cars - 30"
135.0	EA	0840	Z

**Note :**

1. Abbreviations may be used. e.g. (Advance Approach = AA; Diverging Clear = DC; Diverging Approach = DA; Approach = A; Approach Diverging = AD; Restricting = R; Restricted Proceed = RP; Stop = S; Speed Restriction (temporary) = TSR; End of Authority = E/A; Crossing Restrictions (received enroute) = XC, XI, XH, XG; Cab Red Zone = Z; In-Cab Communication = X; ND = No Defects; Restricted Speed = RS.

2. Enter MP location where Cab Red Zone begins and/or in-cab communication takes place when other entries are required. However, entry may be made with signal entry when passing signal.

3. Enter delays.

b. The conductor's report must be completed (and signed on the last page to signify report is complete and accurate) on each trip or tour of duty. If the form is not available, record the information as required. Reports of the last 5 round trips (a minimum of 5 days) must be kept in your possession while on duty, and presented to a Manager upon request.

c. Do not erase information entered on the form. If an error is made, cross out the entry and write the correct entry.

d. Conductors with a valid Class 1 "Certificate to Operate Locomotives": When conductors with a valid Class 1 "Certificate to Operate Locomotives" are allowed to operate the engine the time and location (beginning and ending) will be noted on the conductors report form. Entries on the form will not be required during this time period except entries required by Item 10 K.

**B. Engineer Responsibilities**

**1. Operating the Engine**

The engineer is responsible for safely and efficiently operating the engine. Crew members must obey the engineer's instructions that concern operating the engine. A student engineer or other qualified employee may operate the engine only under the direct and immediate supervision of the engineer. The engineer must closely monitor the employee's performance. The engineer must be in a position to take immediate action as necessary. Employee that operates an engine must have a current certificate in their possession.

**2. Special Handling**

The engineer must check with the conductor to determine if any cars or units in the train require special handling.

**C. All Crew Members' Responsibilities**

**1. Crew Members in Control Compartment**

Crew members in the control compartment must communicate to each other any restrictions or other known conditions and required actions that affect the safe operation of their train sufficiently in advance of such condition to allow the engineer to take proper action. If proper action is not being taken, crew members must remind engineer of such condition and required action.

Crew members in the control compartment must be alert for signals. Crew members must:

- Communicate clearly to each other the name of signals affecting their train as soon as signals become visible or audible.
- Continue to observe signals and announce any change of aspect until the train passes the signal.
- Communicate clearly to each other the speed of the train as it passes a signal with an indication other than Clear.

- Immediately remind the engineer of the rule requirement if the signal is not complied with.

## **2. Radio Transmission**

Except when switching, a crew member must transmit the engine number, direction, location and speed:

**A** Every 2 miles when operating at Restricted Speed.

- **B** Every 5 miles when operating on the main track in PTC territory when PTC is inoperative/defective.
- **C** When approaching the end of authority in non-PTC or when PTC is inoperative/defective unless additional authority has been granted to continue on the main track. Transmission must occur 5 miles in advance of the end of authority, 2 miles before end of authority, 1 mile before end of authority, and when stopped at end of authority.

**D** When head end of train passes a signal that requires:

- - Being prepared to Stop at the next signal.
  - Being prepared to pass next signal at Restricted Speed.
- or
- Restricted speed.

**E** When movement stops for a signal that requires stopping.

- Transmission for signals must include signal name (include track number in multiple main track CTC territory).

Note: Instructions may be issued to identify locations where this radio transmission is not required.

## **3. Proper Action**

If engineer and/or conductor fail to comply with a signal indication or take proper action to comply with a restriction or rule, crew members must immediately take action to ensure safety, using the emergency brake valve to stop the train, if necessary.

## **4. Performing Work**

Before work is performed at a location, the crew must discuss how the work will be performed, which switches/derails will be used, what method will be used to pass signals, close clearances and any other safety related concerns. When work is completed, the crew will confirm that work was completed as planned, switches and derails are in proper position and any unforeseen safety concerns are properly reported.

## **Rule Updated Date**

April 30, 2024

## **System Special Instructions**

Effective Date: July 11, 2023

## **General Order**

Effective Date: April 30, 2024

[^Top](#)

## **1.47.1: Cab Red Zone**



During a Cab Red Zone (CRZ), an environment must be created in the locomotive control compartment that focuses exclusively on controlling the train, verbally communicating restrictions, and proper application of the rules. Crew members must be in the control compartment unless required to perform other duties (i.e. to operate switches, be at a road crossing, passenger train duties, etc.).

A Cab Red Zone exists during critical times such as:

- Operating at Restricted Speed. (Does not apply when switching.)
- Operating on a block signal indication less favorable than Advance Approach.
- Copying mandatory directives.
- Approaching a Form B restriction.
- Approaching a temporary speed restriction that affects the train.
- Approaching the end of the train's authority.

The following restrictions or conditions are required during a Cab Red Zone:

- Cab communication is restricted to immediate responsibilities for safe train operation.
- Radio communication with the dispatcher or other employees must be limited to the train's immediate movement or conditions that affect the safety of trains.
  - When operating in PTC territory and the PTC system is engaged, radio communications are limited only when operating at restricted speed or when the system is in a non-enforcement state.
- A crew member other than the employee operating the controls will be required to handle radio communications when that crew member is in the control compartment.  
Exception: Rule 33.6.1 (Operating Responsibilities with Manned Helper.)
- If proper action is not being taken, crew members must remind each other of the Cab Red Zone and/or take appropriate action to stop the train.

Application: As contained within this rule, approaching is defined as two miles from the restriction or end of the train's authority.

#### **Rule Updated Date**

May 10, 2022

#### **System Special Instructions**

Effective Date: May 10, 2022

[^Top](#)

### **1.47.2: Training and Familiarization**

Employees assigned to a position for the purpose of training or familiarization, as required by System Special Instructions Item 7-B, must be under the direct and immediate supervision of a qualified employee at all times. The qualified employee must closely monitor the employee's performance and must be in a position to take immediate action as necessary. Any employee requiring certification must have a current certificate in their possession.

**Rule Updated Date**

January 23, 2020

**System Special Instructions**

Effective Date: January 23, 2020

[^Top](#)

**1.48: Time**

While on duty, crew members must have a watch. Other employees must have access to a watch or clock.

The watch or clock must:

- Be in good working condition and reliable.
- Display hours, minutes, and seconds.
- Not vary from the correct time by more than 30 seconds.
- Be compared with the time source designated in special instructions.

**Rule Updated Date**

April 7, 2010

[^Top](#)

## [Union Pacific Rules](#)

UPRR - General Code of Operating Rules

# **2.0: RAILROAD RADIO AND COMMUNICATION RULES**

## **Chapter Introduction**

Change Chapter 2.0 title to read:

### **Railroad Radio and Communication Rules**

- [2.1: Transmitting](#)
- [2.2: Required Identification](#)
- [2.3: Repetition](#)
- [2.4: Ending Transmission](#)
- [2.5: Communication Redundancy](#)
- [2.6: Communication Not Understood or Incomplete](#)
- [2.7: Monitoring Radio Transmissions](#)
- [2.8: Acknowledgment](#)
- [2.9: Misuse of Radio Communications](#)
- [2.10: Emergency Calls](#)
- [2.11: Prohibited Transmissions](#)
- [2.12: Fixed Signal Information](#)
- [2.14: Transmission of Mandatory Directives](#)
- [2.14.1: Verbally Transmitting and Repeating Mandatory Directives](#)
- [2.15: Phonetic Alphabet](#)
- [2.16: Assigned Frequencies](#)
- [2.17: Radio Testing](#)
- [2.18: Malfunctioning Radio](#)
- [2.19: Blasting Operations](#)
- [2.20: Internal Adjustments](#)
- [2.21: Electronic Devices](#)

## **2.1: Transmitting**

Any employee operating a radio must do the following:

- Before transmitting, listen long enough to make sure the channel is not being used.
- Give the required identification
- Not proceed with further transmission until acknowledgment is received .

**Application:****Normal Dispatcher Call-in Procedure**

To contact the train dispatcher from the field:

1. Ensure that you are on the correct dispatcher radio channel for the area you are in. The radio channel is identified in timetable subdivision instructions under Radio Display (SI-RD).
2. On the radio key pad, dial "\*" plus the 2-digit code for the dispatcher you wish to call. (For example, "\*20").

**Note:** After dialing the "\*XX" digits, you should receive an acknowledgment tone on your radio indicating the call-in has been detected and processed. If you do not hear the acknowledgment tone you will need to re-dial the code.

**Rule Updated Date**

April 1, 2015

**System Special Instructions**

Effective Date: April 1, 2015

[^Top](#)

**2.2: Required Identification**

Employees transmitting or acknowledging a radio communication must begin with the required identification. The identification must include the following in this order:

- For base or wayside stations:
  - Name or initials of the railroad
  - Name and location or other unique designation
- For mobile units:
  - Name or initials of the railroad
  - Train name (number), engine number, or words that identify the precise mobile unit.

**Short Identification**

After making a positive identification for switching, classification, and similar operations within a yard, fixed and mobile units may use a short identification after the initial transmission and acknowledgment.

**Application:**

During switching operations, short identification must be unique enough to ensure no misunderstanding as to whom the communication is intended for or could be misinterpreted. Job numbers alone could be misinterpreted as car counts, track number or other equipment etc. "10 back up 5" must not be used. Instead use "Job 10 back up 5 cars; Yard Job 10 back up 5 cars" or "DY10 back up 5 cars".

**Rule Updated Date**

May 10, 2022

## **System Special Instructions**

Effective Date: May 10, 2022

[^Top](#)

### **2.3: Repetition**

An employee who receives a transmission must repeat it to the person transmitting the message, except when the communication:

- Concerns yard switching operations.
- Is a recorded message from an automatic alarm device.  
or
- Is general and does not contain any information, instruction, or advice that could affect the safety of a railroad operation.

When a mandatory directive or instruction concerning train movement has been repeated correctly, the repeat must be acknowledged as correct.

## **Rule Updated Date**

April 1, 2015

## **System Special Instructions**

Effective Date: April 1, 2015

[^Top](#)

### **2.4: Ending Transmission**

Employees using a radio for transmissions must state to the employee receiving the transmission the following as it applies to indicate the communication has ended or is completed:

"OVER" - when a response is expected

or

"OUT" preceded by required identification - when no response is expected.

However, these requirements do not apply to yard switching operations.

## **Rule Updated Date**

April 7, 2010

[^Top](#)

## 2.5: Communication Redundancy

The controlling unit of any train that requires an air brake test must be equipped with an operative radio, unless relieved by Rule 2.18 (Malfunctioning Radio). In addition, these trains must have a second means of communication, which may include:

- An operative radio on any unit in the consist.
- A portable radio  
or
- Other wireless communication device.

Application:

Use of a wireless communication device for voice communication by railroad operating employees while inside the cab of a controlling locomotive on a moving train or when fouling a track is prohibited unless usage is due to radio malfunction and all crew members agree it is safe to use.

### Rule Updated Date

December 1, 2023

### General Order

Effective Date: December 1, 2023

[^Top](#)

## 2.6: Communication Not Understood or Incomplete

An employee who does not understand a radio communication or who receives a communication that is incomplete must not act upon the communication and must treat it as if it was not sent.

<p><b>EXCEPTION:</b> An employee who receives information that may affect the safety of employees or the public or cause damage to property must take the safe course. When necessary, stop movement until the communication is understood.</p>
---

### Rule Updated Date

April 7, 2010

[^Top](#)

## 2.7: Monitoring Radio Transmissions

Radios in attended base stations or mobile units must be turned on to the appropriate channel with the volume loud enough to receive communications. Employees attending base stations or mobile units must acknowledge all transmissions directed to the station or unit.

**Rule Updated Date**

April 7, 2010

[^Top](#)

## **2.8: Acknowledgment**

An employee receiving a radio call must acknowledge the call immediately unless doing so would interfere with safety.

**Rule Updated Date**

April 7, 2010

[^Top](#)

## **2.9: Misuse of Radio Communications**

<b>Employees must not use radio communication to avoid complying with any rule.</b>
---

**Rule Updated Date**

April 7, 2010

[^Top](#)

## **2.10: Emergency Calls**

Emergency calls will begin with the words "Emergency, Emergency, Emergency". These calls will be used to cover initial reports of hazardous conditions which could result in death or injury, damage to property or serious disruption of railroad operations such as:

- Derailments
- Collisions
- Storms
- Washouts
- Fires
- Track obstructions
- or
- Emergency brake applications.

In addition, emergency calls must be made for the following:

- Overrunning limits of authority  
or
- Overrunning Stop indications.

Emergency calls must contain as much complete information on the incident as possible.

All employees must give absolute priority to an emergency communication. Unless they are answering or aiding the emergency call, employees must not transmit until they are certain no interference will result.

**Application:**

**Emergency Call-in Procedure**

The Emergency call-in code is "911" throughout the entire UPRR system. To contact the train dispatcher in case of an emergency:

1. Ensure that you are on the dispatcher's radio channel for the area you are in. The radio channel is identified in timetable subdivision instructions under Radio Display (SI-RD).
2. Dial DTMF digits "911" on the radio key pad.

**Note:** After dialing the "911" digits, you should receive an acknowledgment tone on your radio indicating the emergency call-in has been detected and processed. If you do not hear the acknowledgment tone you will need to resend the "911" code.

**Rule Updated Date**

April 1, 2015

**System Special Instructions**

Effective Date: April 1, 2015

[^Top](#)

**2.11: Prohibited Transmissions**

Employees must not transmit a false emergency or an unnecessary or unidentified communication. Employees must not use indecent language over the radio. Employees must not reveal the existence, contents, or meaning of any communication (except emergency communications) to persons other than those it is intended for, or those whose duties may require knowing about it.

**Rule Updated Date**

April 7, 2010

[^Top](#)

**2.12: Fixed Signal Information**



Employees must not use the radio to give information to a train or engine crew about the name, position, aspect, or indication displayed by a fixed signal, unless the information is given between members of the same crew or the information is needed to warn of an emergency.

**Rule Updated Date**

April 7, 2010

[^Top](#)

## **2.14: Transmission of Mandatory Directives**

When transmitted by radio, mandatory directives must conform to applicable operating rules and the following:

- The train dispatcher must state which mandatory directive will be transmitted.
- The employee must inform the train dispatcher when ready to copy stating the employee's occupation (ex. conductor, engineer, foreman, maintainer), name and location on the main track or where the main track will be entered. An employee operating the controls of a moving engine may not copy mandatory directives. In addition, mandatory directives must not be transmitted to the crew of a moving train if the conductor, engineer or train dispatcher feels that the transmission could adversely affect the safe operation of the train.
- The employee receiving a mandatory directive must copy it in writing using the format outlined in the operating rules.
- Before a mandatory directive is acted upon, the conductor and engineer must each have a written copy and each crew member must read and understand it.

**Rule Updated Date**

May 10, 2022

**System Special Instructions**

Effective Date: May 10, 2022

[^Top](#)

### **2.14.1: Verbally Transmitting and Repeating Mandatory Directives**

When transmitting and repeating mandatory directives, numbers must be spoken by digit (zero, one, two, three, etc.). However, exact multiples of hundreds and thousands may be stated as such (600 = six hundred). A decimal point must be spoken as "point", "dot", or "decimal", and a hyphen must be spoken as "dash".

**Rule Updated Date**

May 5, 2021

**System Special Instructions**

Effective Date: May 5, 2021

[^Top](#)

## **2.15: Phonetic Alphabet**

If necessary, a phonetic alphabet (Alpha, Bravo, Charlie, etc.) will be used to pronounce clearly any letter used as an initial, except initial letters of the railroads.

### **Rule Updated Date**

April 7, 2010

[^Top](#)

## **2.16: Assigned Frequencies**

The railroad must authorize any radio transmitters used in railroad service. Radio transmitter must operate on frequencies the Federal Communications Commission assigned the railroad. Employees are prohibited from using other transmitters or railroad frequencies not assigned to that particular territory.

### **Rule Updated Date**

April 7, 2010

[^Top](#)

## **2.17: Radio Testing**

Test radios to be used as soon as possible before beginning of work assignment.

The radio test must include an exchange of voice transmissions with another radio. The test must confirm the quality of the radio's transmission.

### **Rule Updated Date**

April 7, 2010

[^Top](#)

## **2.18: Malfunctioning Radio**

Malfunctioning radios must not be used. As soon as possible, notify each crew member and the train dispatcher or other affected employees that the radio is not working.

If a radio fails on the controlling locomotive enroute, the train may continue until:

- The next calendar day inspection
- **OR**
- The nearest forward point where the radio can be repaired or replaced, whichever occurs first.

**Rule Updated Date**

April 7, 2010

[^Top](#)

**2.19: Blasting Operations**

Employees must not operate radio transmitter located less than 250 feet from blasting operations.

**Rule Updated Date**

April 7, 2010

[^Top](#)

**2.20: Internal Adjustments**

Employees are prohibited from making internal adjustments to a railroad radio unless they are specifically authorized by the FCC or hold a current Certified Technicians Certificate. Employees authorized to make adjustments must carry their FCC operator license, Certified Technicians Certificate, or verification card while on duty.

**Rule Updated Date**

April 7, 2010

[^Top](#)

**2.21: Electronic Devices**

The restrictions in this rule apply to both the use of railroad-supplied and personal electronic devices by railroad operating employees and does not affect the use of railroad radios under FRA regulations. A railroad operating employee shall not use an electronic device if that use would interfere with the employee's or another railroad operating employee's performance of safety-related duties. No individual in the cab of a controlling locomotive shall use an electronic device if that use interferes with a railroad operating employee's performance of safety-related duties.

**Railroad-Supplied and Personal Electronic Devices**

- Electronic devices may be used to respond to an emergency situation involving the operation of the railroad, an emergency encountered on duty, or when necessary due to a radio malfunction.
- Electronic devices may be used while deadheading in a non-controlling locomotive or automobile, limo, etc., or when in the body of a business car or passenger train and use will not interfere with any railroad operating employee's personal safety.
- Electronic devices must not be used to verbally obtain or release a mandatory directive when radio communication is available.
- A stand-alone calculator may be used.
- A digital watch whose only purpose is as a timepiece may be worn while on duty.

- Medical devices may be used that are consistent with railroad's standards as necessary in the performance of duties.

Crew members are jointly responsible for compliance with the appropriate use of electronic devices.

### **Railroad-Supplied Electronic Devices**

Employees issued a railroad-supplied electronic device must log into the system at the start of tour of duty and must remain logged in until completion of tour of duty for authorized business purposes such as:

- Timely, automated updating or transmission of information.
- View or modify switch lists, track lists, work orders, etc.
  - Note: For Reporting Completion of Work, refer to System Special Instructions Item 15.
- Exchange work related information with railroad supervisors, dispatchers, customers, NCSC, or customer service employees.
- Receiving or releasing Track Warrant authority when PTC system is inoperative or lead locomotive is not PTC equipped.
- Taking a photograph of a safety hazard, defect, or a violation of a rail safety law, regulation, order, or standard. The camera function must be turned off immediately after the photograph is taken and the camera is not used by an employee at the controls of moving equipment.

As outlined above, railroad operating employees may use a railroad-supplied electronic device outside the cab of a controlling freight locomotive only if the employee is not fouling a track and all crew members agree it is safe to use.

The use of railroad-supplied electronic devices by an engineer while operating the controls of a locomotive is prohibited:

- While on a moving train, unless device use is directly related to the movement of the train, i.e. to reference a railroad rule, special instruction, timetable, or other directive.  
or
- When any crew member (including utility employees) is working on the ground, or riding rolling equipment during switching operations, or when any other employee is assisting in the preparation of the train.
  - These prohibitions also apply to other operating employees in the locomotive cab unless a safety briefing is conducted, and all agree it is safe for other operating employees to use.

The assigned employee is responsible for the device and care must be taken not to lose or damage the device. A railroad-supplied electronic device must not be used for purposes other than which it was intended.

Railroad-supplied electronic devices must be powered off with any earpiece removed from the ear and stowed when not in use as outlined above.

At the end of tour of duty, the device must be returned to the pool device location and remain on and plugged into a charger. If a device is assigned to an employee or the employee is staying at the away from home terminal, the assigned employee needs to ensure the device is left on and charging for use on their next tour of duty.

### **Personal Electronic Devices**

#### **A. Prohibited Use:**

Personal electronic devices are prohibited from use while on duty in safety-related situations and must be turned off and

stowed with any earpiece removed from the ear. Except as described below, use by any crew member in the cab of a controlling locomotive is prohibited when:

- On a moving train, (except as described below under Permitted Use).
- Any member of the crew is on the ground or on moving equipment.
- Any railroad employee or authorized individual is inspecting or assisting in preparation of the train, engine or on-track equipment for movement.

**B. Permitted Use:**

Use of a personal electronic device at any time must not result in delays or interfere with safety-related duties of any crew member, other employees, or personnel. After conducting a safety briefing, and agreeing the use of the device is safe, a personal electronic device may be used as follows:

- In the cab of a controlling locomotive while moving to reference a railroad rule, special instruction, timetable, or other directive provided the wireless capability of the device is disabled. The device must not be used by an employee at the controls of moving equipment.
- A camera may be used to take a photograph of a safety hazard or a violation of a rail safety law, regulation, order or standard provided it is a standalone camera. A camera that is part of a cell phone or other similar multi-functional electronic device is not included in this exception unless it is a railroad-supplied device and is used for an authorized business purpose. The camera must be turned off immediately after the photograph is taken and the camera is not used by an employee at the controls of moving equipment.
- In the cab of a controlling locomotive while stopped, or when in a crew room or other designated location for voice communication, texting or to update railroad rules, special instructions, timetables, directives or other company provided electronic documents. An electronic device may be used for other purposes, including accessing the internet for personal use when:
  - All job related duties have been completed.
  - All assigned online training items have been completed.
  - All broadcast messages contained in My UP portal have been read and acknowledged.

**Rule Updated Date**

March 15, 2023

**System Special Instructions**

Effective Date: July 11, 2023

[^Top](#)

[Union Pacific Rules](#)

UPRR - General Code of Operating Rules

### **3.0: Section Reserved**

- [RESERVE: Section Reserved](#)

### **RESERVE: Section Reserved**

**Rule Updated Date**

April 7, 2010

[^Top](#)

## [Union Pacific Rules](#)

### UPRR - General Code of Operating Rules

## **4.0: TIMETABLES**

- [4.1: New Timetable](#)
- [4.1.1: Notice of New Timetable](#)
- [4.2: Special Instructions](#)
- [4.3: Timetable Characters](#)

### **4.1: New Timetable**

The moment a new timetable goes into effect, it will replace the previous one.

#### **Rule Updated Date**

April 7, 2010

[^Top](#)

### **4.1.1: Notice of New Timetable**

At least 24 hours before a new timetable goes into effect, notification will be made by general order. A track bulletin will also be issued at least 24 hours before the new timetable goes into effect and continue for 6 days after the effective date.

#### **Rule Updated Date**

April 7, 2010

[^Top](#)

### **4.2: Special Instructions**

Special instructions will replace any rule or regulation with which they conflict.

#### **Rule Updated Date**

April 7, 2010

[^Top](#)

### **4.3: Timetable Characters**

Timetable characters are letters and symbols located in the timetable station column. These letters and symbols indicate the special conditions at specific locations (such as yard limits and manual interlockings). A timetable station column may also

include information on the method of operation (such as TWC, ABS, CTC, or DTC). Explanation of characters will be shown in the timetable or special instructions.

**Rule Updated Date**

April 1, 2015

[^Top](#)



## Union Pacific Rules

### UPRR - General Code of Operating Rules

## **5.0: SIGNALS AND THEIR USE**

- [5.1: Signal Equipment](#)
- [5.2: Receiving and Giving Signals](#)
- [5.2.1: Looking for Signals](#)
- [5.2.2: Signals Used by Employees](#)
- [5.3: Hand and Radio Signals](#)
- [5.3.1: Hand Signals](#)
- [5.3.2: Giving Signals](#)
- [5.3.3: Signal Disappearance](#)
- [5.3.4: Signal to Stop](#)
- [5.3.5: Acknowledge Stop Signal](#)
- [5.3.6: Radio and Voice Communication](#)
- [5.3.7: Radio Response](#)
- [5.4: Flags for Temporary Track Conditions](#)
- [5.4.1: Temporary Restrictions](#)
- [5.4.2: Display of Yellow Flag](#)
- [5.4.3: Display of Yellow-Red Flag](#)
- [5.4.4: Reserved](#)
- [5.4.5: Display of Green Flag](#)
- [5.4.6: Display of Flags Within Current of Traffic](#)
- [5.4.7: Display of Red Flag](#)
- [5.4.8: Flag Location](#)
- [5.5: Permanent Speed Signs](#)
- [5.6: Unattended Fusee](#)
- [5.8: Bell and Whistle Signals](#)
- [5.8.1: Ringing Engine Bell](#)
- [5.8.2: Sounding Whistle](#)
- [5.8.3: Whistle Failure](#)
- [5.8.4: Whistle Quiet Zone](#)
- [5.8.5: Silenced Whistle](#)
- [5.9: Headlight Display](#)
- [5.9.1: Dimming Headlight](#)
- [5.9.2: Headlight Off](#)
- [5.9.3: Headlight Failure](#)
- [5.9.4: Displaying Headlights Front and Rear](#)

- [5.9.5: Displaying Ditch Lights](#)
- [5.9.6: Displaying Oscillating White Headlight](#)
- [5.9.7: Displaying Oscillating or Flashing Red Light](#)
- [5.9.8: Displaying Cab Roof Light](#)
- [5.10: Markers](#)
- [5.10.1: Highly Visible Markers](#)
- [5.10.2: Alternative Markers](#)
- [5.11: Engine Identifying Number](#)
- [5.12: Protection of Occupied Outfit Cars](#)
- [5.13: Blue Signal Protection of Workmen](#)
- [5.13.1: Utility Employees](#)
- [5.14: Signs Protecting Equipment](#)
- [5.14.1: Contractor Protection for Servicing Locomotives](#)
- [5.15: Improperly Displayed Signals](#)

## **5.1: Signal Equipment**

Employees who give or display signals must have the proper appliances. Appliances must be in good condition and ready to use.

### **Rule Updated Date**

April 7, 2010

[^Top](#)

## **5.2: Receiving and Giving Signals**

### **Rule Updated Date**

April 7, 2010

[^Top](#)

### **5.2.1: Looking for Signals**

To recognize and follow signals correctly, employees must:

- Always be on the lookout for signals.
- Comply with the intent of the signal.
- Not act on any signal that they do not understand or that may be intended for other trains or engines

**Application:**

Engineering department employees performing lookout duties (wearing a yellow/green vest with orange reflectorized striping, with "Lookout" printed on the vest) may be communicating with their work group with a white flag. This white flag is not a signal to the train, rather a signal to the work group that an approaching train has been spotted.

**Rule Updated Date**

April 1, 2015

**System Special Instructions**

Effective Date: April 1, 2015

[^Top](#)

**5.2.2: Signals Used by Employees**

To give clear signals during the day and night, employees must:

**A. During the Day**

1. Use the correct color of flags or lights.
2. Use day signals from sunrise to sunset.
3. Flagmen providing protection as outlined in Rule 6.19 must have a red flag and six red fuses.

**B. At Night**

1. Use the correct color of reflectorized flags or lights.
2. Use night signals from sunset to sunrise or when day signals cannot be seen clearly.
3. Flagmen providing protection as outlined in Rule 6.19 must have a white light and six red fuses.

Flags may be made from cloth, metal or other suitable material.

**Rule Updated Date**

April 7, 2010

[^Top](#)

**5.3: Hand and Radio Signals****Rule Updated Date**

April 7, 2010

[^Top](#)

### 5.3.1: Hand Signals

The following diagram illustrates the hand signals for a train or engine to stop, proceed, or backup.

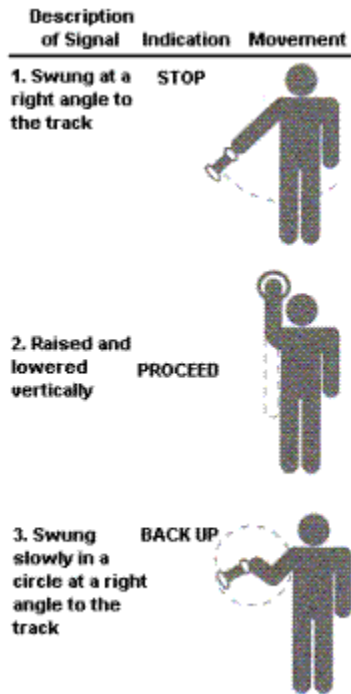

[Diagram A]

Employees may use other hand signals only if all crew members understand the signals. When employees are not giving hand signals, they must not make any gestures or movements that may resemble a hand signal.

#### Rule Updated Date

April 7, 2010

[^Top](#)

### 5.3.2: Giving Signals

Employees who give signals must:

- Make sure signals can be plainly seen.
- Give signals clearly so they can be understood.
- Give signals on the engineer's side of the track when practical.

#### Rule Updated Date

April 7, 2010

[^Top](#)

### **5.3.3: Signal Disappearance**

If a person disappears who is giving the signal to back or shove a train, engine, or car, or the light being used disappears, employees must

stop movement unless employee on leading car controls the air brakes.

#### **Rule Updated Date**

April 1, 2015

[^Top](#)

### **5.3.4: Signal to Stop**

**ANY OBJECT WAVED VIOLENTLY BY ANY PERSON ON OR NEAR THE TRACK IS A SIGNAL TO STOP.**

#### **Rule Updated Date**

April 7, 2010

[^Top](#)

### **5.3.5: Acknowledge Stop Signal**

Except when switching, acknowledge hand signal to stop a train. When flagged, the engineer must obtain a thorough explanation from the flagman before proceeding.

#### **Rule Updated Date**

April 7, 2010

[^Top](#)

### **5.3.6: Radio and Voice Communication**

Employees may use radio and other means of voice communication to give information when using hand signals is not practical.

Employees must make sure crew members:

- Know which moves will be made by radio communication.
- Understand that while using the radio, the engineer will not accept any hand signals, unless they are Stop signals.

#### **Rule Updated Date**

April 7, 2010

[^Top](#)

### **5.3.7: Radio Response**

**Delete entire rule.**

**Rule Updated Date**

April 1, 2015

**System Special Instructions**

Effective Date: April 1, 2015

[^Top](#)

### **5.4: Flags for Temporary Track Conditions**

**Rule Updated Date**

April 7, 2010

[^Top](#)

#### **5.4.1: Temporary Restrictions**

Track bulletins, track warrants, or general orders may restrict or stop train movements because of track conditions, structures or men or equipment. Yellow flags are used to indicate temporary speed restrictions. Yellow-red flags are used to indicate when a train may be required to stop. When flags are not displayed, that information will be included in the track bulletin, track warrant, or general order.

When a restriction spans adjoining subdivisions, separate temporary restrictions may be issued on each subdivision. Only one set of flags may be displayed in advance of the entire restriction in each direction.

**Rule Updated Date**

April 7, 2010

[^Top](#)

#### **5.4.2: Display of Yellow Flag**

**A. Restriction is in Effect.**

**Two Miles Ahead of Restricted Area.** Yellow flags warn trains to restrict movement because of track conditions or structures. To make sure train movement is restricted at the right location, employees must display a yellow flag 2 miles before the restricted area.

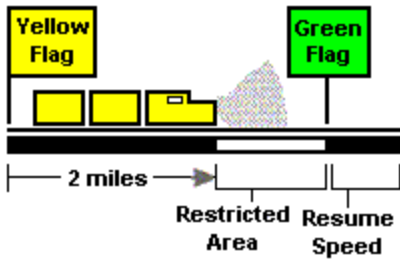

[Diagram A]^

**Less than Two Miles Ahead of Restricted Area.** When the restricted area is close to a terminal, junction or another area, employees will display the yellow flag less than 2 miles before the restricted area. This information will also be included in the track bulletin, track warrant, or general order.

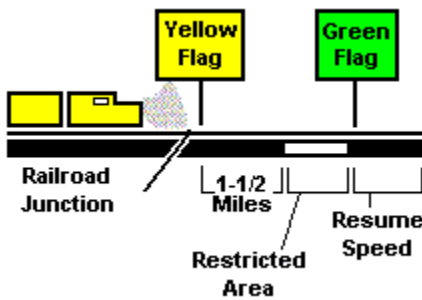

[Diagram B]^

**Once the Train Reaches the Restricted Area.** The speed specified by track warrant, track bulletin, general order, or radio speed restriction must not be exceeded until the rear of the train clears the restricted area.

## B. Restriction Is Not in Effect

When a yellow flag is displayed and no restriction is in effect as specified by a track bulletin, track warrant or general order, once the train is 2 miles beyond the yellow flag, crew members must:

- 1 Continue moving the train but at a speed not exceeding 10 MPH.
- 2 Resume speed only after the rear of the train has:
  - Passed a green flag.
    - a or
    - b Traveled 4 miles beyond the yellow flag and the train dispatcher has verified that no track bulletin or track warrant is in effect specifying a temporary speed restriction at that location.

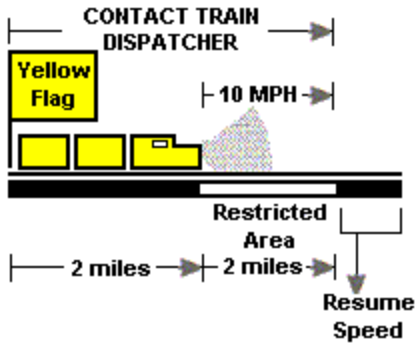

[Diagram C]^

**Rule Updated Date**

April 1, 2015

[^Top](#)

**5.4.3: Display of Yellow-Red Flag**

Employees may display yellow-red flags from one hour before the track bulletin Form B takes effect until one hour after it expires. During that time the employee in charge may provide a train instructions to proceed without restriction, specifying the Track Bulletin number (specifying line number when necessary) and advising no red flag displayed.

The display of yellow-red flags as described does not extend the authorized working time beyond the times listed on the track bulletin Form B.

**A. Restriction Is In Effect**

**Two Miles Ahead of Restricted Area.** Yellow-red flags warn a train to be prepared to stop because of men or equipment. To make sure the train is prepared to stop at the right location, employees must display a yellow-red flag 2 miles before the restricted area.

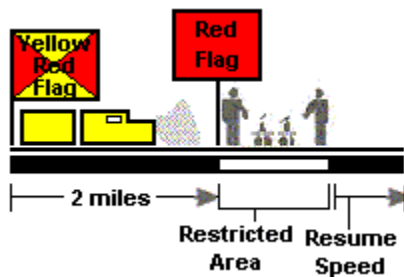

[Diagram A]^

**Less Than Two Miles Ahead of Restricted Area.** When the restricted area is close to a terminal, junction, or another area, employees will display the yellow-red flag less than 2 miles before the restricted area. This information will also be included in the track bulletin, track warrant or general order.



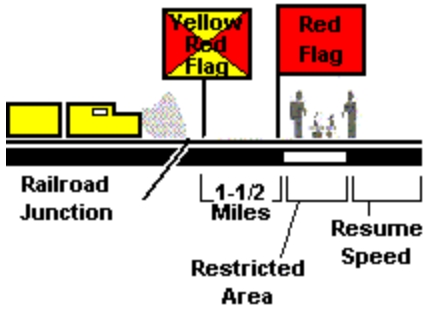

[Diagram B]^

## B. Restriction Is Not In Effect

When a yellow-red flag is displayed and no restriction is in effect as specified by a track bulletin, track warrant, or general order, a crew member must attempt to contact the employee in charge of the yellow-red flag. Crew members must be prepared to stop short of a red flag 2 miles beyond the yellow-red flag. If a red flag is displayed, proceed as outlined in Rule 5.4.7 (Display of Red Flag). If no red flag is displayed:

- 1 Move at restricted speed.
- 2 Increase speed only after:
  - A crew member has received instructions from the employee in charge.
    - a or
    - b The leading wheels of movement are 4 miles beyond the yellow-red flag, and the train dispatcher has verified
      - that no track bulletin or track warrant protecting men or equipment is in effect at that location.

### Rule Updated Date

April 1, 2015

[^Top](#)

## 5.4.4: Reserved

### Rule Updated Date

October 10, 2017

### System Special Instructions

Effective Date: June 1, 2018

[^Top](#)

## 5.4.5: Display of Green Flag

A green flag indicates the end of a temporary speed restriction. If a series of locations require reduced speeds, the green flags could overlap yellow flags. When this is the case, employees must:

- Place a yellow flag before each speed restriction
- Place a green flag at the end of the last speed restriction.

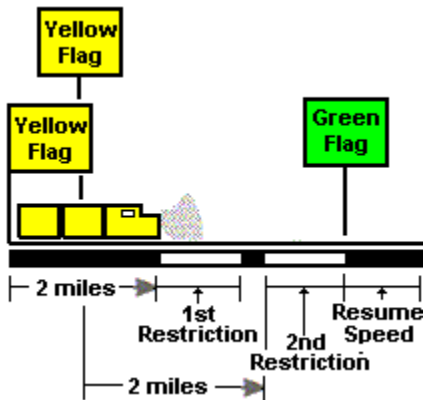

[Diagram A]

**Rule Updated Date**

April 7, 2010

[^Top](#)

**5.4.6: Display of Flags Within Current of Traffic**

**A. Yellow and Green Flags**

Flags for temporary speed restrictions will only be placed for trains moving with the current of traffic.

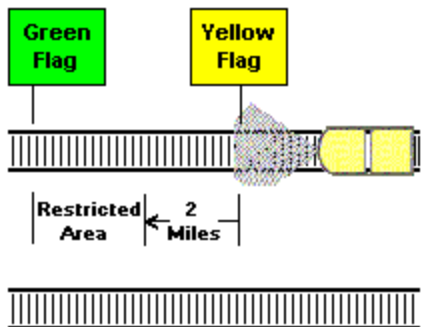

[Diagram A]

**B. Yellow-Red Flags**

Flags protecting men or equipment must be placed in both directions on each track affected.

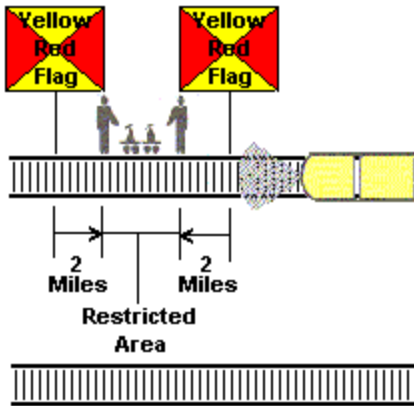

[Diagram B]

#### Rule Updated Date

April 7, 2010

[^Top](#)

### 5.4.7: Display of Red Flag

A red flag is displayed where trains must stop. When approaching a red flag, the train must stop short of the red flag and not proceed unless the employee in charge gives instructions, including the milepost location of the red flag. A crew member must attempt to contact the employee in charge to avoid delay, giving the location of the red flag and the track being used. If instructions to proceed are received before the train stops, the train may pass the red flag without stopping.

If track bulletin Form B is not in effect, instructions must include speed and distance. This speed must not be exceeded until the rear of the train has passed the specified distance from the red flag, unless otherwise instructed by the employee in charge.

**Displayed Between Rails.** When a red flag is displayed between the rails of a track, the train must stop and not proceed until the flag has been removed by an employee of the class that placed it.

#### Rule Updated Date

April 1, 2015

[^Top](#)

### 5.4.8: Flag Location

Flags will be displayed only on the track affected. However, when yellow, yellow-red, or red flags are used for protection without a track bulletin, track warrant, or general order, these flags must be placed to protect all possible access to the restricted area.

Flags must be displayed to the right of the track as viewed from an approaching train. In multiple main track territory or where sidings are adjacent to main track(s), they will be placed on the field side of outside tracks. Red flags may be displayed between the rails as outlined in Rule 5.4.7 (Display of Red Flag). Flags will be placed in this manner unless otherwise specified by track bulletin, track warrant, special instructions, or general order.

When flags are displayed beyond the first rail of an adjacent track, the flags will not apply to the track on which the train is moving.

**Application:**

In three or more main track territory, flags will be displayed to the right of center tracks (inside tracks) where clearance allows.

**Rule Updated Date**

April 1, 2015

**System Special Instructions**

Effective Date: April 1, 2015

[^Top](#)

### 5.5: Permanent Speed Signs

Permanent speed restriction signs will be placed in advance of permanent speed restrictions. Numbers on the face of these signs indicate the highest speed permitted over the limits of the restriction.

**Two Sets of Numbers**

When two sets of numbers are shown, the greater number governs trains consisting entirely of passenger equipment. The lesser number governs all other trains.

**Resume Speed Signs**

A permanent resume speed sign or a speed sign showing a higher speed will be placed at the end of each restriction.

Crew members must not exceed the speed shown on each permanent speed restriction sign until the rear of the train:

- Has passed a permanent resume speed sign or a sign showing a higher speed.  
or
- Has cleared the limits of the restriction.

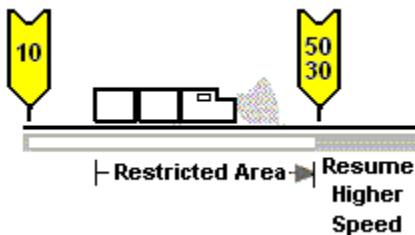

[Diagram A]^

**Application:**

The location of permanent speed signs are:

- 2500 feet ahead of the restriction (Arrow-shaped signs).

- 2 miles ahead of the restriction (Square or rectangular signs).

**Rule Updated Date**

April 1, 2015

**System Special Instructions**

Effective Date: April 1, 2015

[^Top](#)

**5.6: Unattended Fusee**

If a train approaches an unattended fusee burning on or near its track, the train must stop consistent with good train handling.

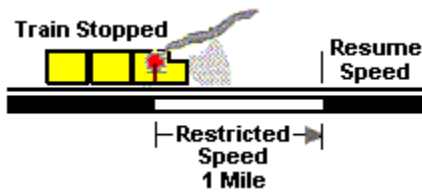

[Diagram A]

A train moving at restricted speed must stop before passing the fusee.

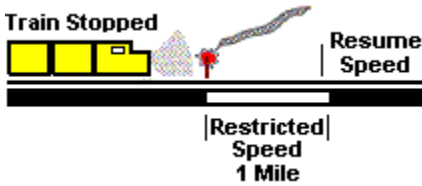

[Diagram B]

After stopping, the train must proceed at restricted speed for 1 mile beyond the fusee.

If the unattended burning fusee is beyond the first rail of an adjacent track, the fusee does not apply to the track on which the train is moving.

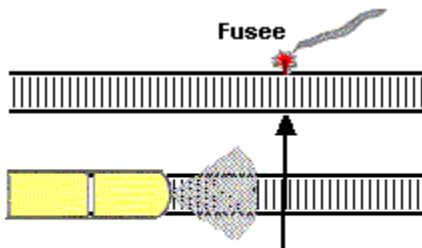

**Fusee does not apply when it is beyond the first rail of an adjacent track**

[Diagram C]

Do not place fusees where they may cause fires.

**Rule Updated Date**

April 7, 2010

[^Top](#)

## **5.8: Bell and Whistle Signals**

**Rule Updated Date**

April 7, 2010

[^Top](#)

### **5.8.1: Ringing Engine Bell**

Ring the engine bell under any of the following conditions:

- Before moving, except when making momentary stop and start switching movements.
- As a warning signal anytime it is necessary.
- When approaching men or equipment on or near the track.
- When moving on the main track or siding, ring bell continuously while passing standing equipment on an adjacent track.
- Approaching public crossings at grade with the engine in front start signal at the crossing sign. If no sign, or if movement begins between sign and crossing, start signal soon enough before crossing to provide warning. Continue ringing bell until the crossing is occupied.
- When moving in a designated mechanical facility, ring bell continuously.

**Rule Updated Date**

June 1, 2017

**System Special Instructions**

Effective Date: June 1, 2017

[^Top](#)

### **5.8.2: Sounding Whistle**

The whistle may be used at any time as a warning regardless of any whistle prohibitions. When approaching areas where it is known employees are working or seen on a track adjacent to a main track or siding, sound warning.

When other employees are working in the immediate area, sound the required whistle signal before moving.

Other forms of communications may be used in place of whistle signals, except signals (1), (7) and (8). See following chart.

The required whistle signals are illustrated by "o" for short sounds and "-" for longer sounds.

SOUND	INDICATION
[1] Sound whistle to attempt to attract attention to the train.	Use when persons or livestock are on the track at other than road crossings at grade. Use when within quiet zones when engineer believes such action is appropriate. When unable to determine an employees work group, sound signal 5.8.2 (8).
[2] -	When stopped: air brakes are applied, pressure equalized.
[3] - -	Release brakes. Proceed
[4] o o	Acknowledgement of any signal not otherwise provided for.
[5] o o o	When stopped: back up. Acknowledgment of hand signal to back up.
[6] o o o o	Request for signal to be given or repeated if not understood.
[7] - - o -	<p>When approaching public crossings at grade, with engine in front, sound signal as follows:</p> <p>A. At speeds in excess of 45 MPH, start signal at or about the crossing sign but not more than 1/4 mile before the crossing.</p> <p>B. At speeds of 45 MPH or less, start signal at least 15 seconds, but not more than 20 seconds, before entering the crossing.</p> <p>C. If no crossing sign, start signal at least 15 seconds, but not more than 20 seconds, before entering crossing, but not more than 1/4 mile before the crossing.</p> <p>D. If movement starts less than 1/4 mile from a crossing, signal may be sounded less than 15 seconds before entering the crossing when it is clearly seen traffic is not approaching the crossing, traffic is not stopped at the crossing or when crossing gates are fully lowered.</p> <p>Prolong or repeat signal until the engine completely occupies the crossing(s).</p> <p>At locations where crossing signs are displayed sound whistle as required above regardless of the type of crossing train is approaching.</p> <p>In the states of California and Montana sound whistle signal at all crossings, public and private.</p>
[8] - o	<p>Approaching men or equipment on or near the track, regardless of any whistle prohibitions.</p> <p>After this initial warning, sound whistle signal (4) intermittently until the head end of train has passed the men or equipment.</p>

**Rule Updated Date**

May 10, 2019

**System Special Instructions**

Effective Date: May 10, 2019

[^Top](#)

### **5.8.3: Whistle Failure**

If the whistle fails to operate and no other unit can be used as the lead unit, continue movement with the bell ringing continuously. Stop the train before each public crossing, so a crew member on the ground can provide warning until the crossing is occupied, unless:

- Crossing gates are in the fully lowered position.  
or
- No traffic is approaching or stopped at the crossing.

#### **Rule Updated Date**

April 7, 2010

[^Top](#)

### **5.8.4: Whistle Quiet Zone**

Within designated whistle quiet zones, whistle signal (7) must not be sounded approaching public crossing at grade except when:

- Necessary to provide warning in an emergency.
- Notified automatic warning devices are malfunctioning.
- Notified automatic warning devices are out of service.  
or
- The whistle quiet zone is not in effect during specified hours.

#### **Rule Updated Date**

April 7, 2010

[^Top](#)

### **5.8.5: Silenced Whistle**

Whistle signal (7) is not required when approaching a public crossing at grade when:

- Permanent maximum authorized track speed is 15 MPH or less,
- Active grade crossing warning devices, if equipped, are operating as intended,  
and
- Crew member is on the ground at the crossing to provide warning until crossing is occupied.

#### **Rule Updated Date**

April 1, 2015



[^Top](#)

## 5.9: Headlight Display

Turn the headlight on bright to the front of every train, except when the light must be dimmed as outlined in Rule 5.9.1 (Dimming Headlight) or turned off as outlined in Rule 5.9.2 (Headlight Off).

### Rule Updated Date

April 7, 2010

[^Top](#)

### 5.9.1: Dimming Headlight

Approaching public crossings at grade with engine in front, the headlight must be on bright at the crossing sign. If no sign, or if movement begins between sign and crossing, the headlight must be on bright soon enough before the crossing to provide warning. Except when the engine is approaching and passing over a public crossing at grade, dim the headlight during any of the following conditions:

1. At stations and yards where switching is being done.

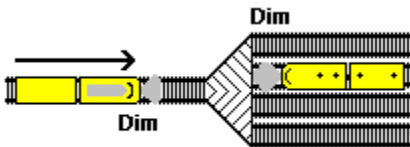

[Diagram A]

2. When stopped close behind another train.

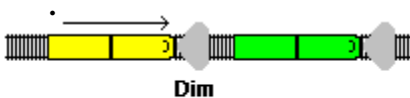

[Diagram B]

3. When stopped on the main track waiting for an approaching train. However, when stopped in block system limits, turn the headlight off at the radio request of the crew of an approaching train, until the head end of the train passes.

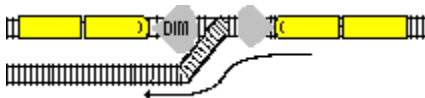

[Diagram C]

4. When approaching and passing the head end of a train at night.

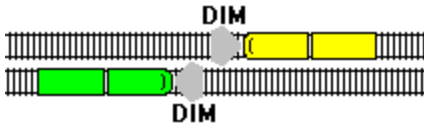

[Diagram D]

- At other times to permit passing of hand signals or when the safety of employees requires.

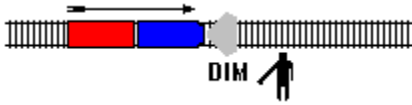

[Diagram E]

- When left unattended on a main track in non-signaled territory.

**Rule Updated Date**

April 7, 2010

[^Top](#)

**5.9.2: Headlight Off**

Turn the headlight off under either of the following conditions:

- The train is stopped clear of the main track.

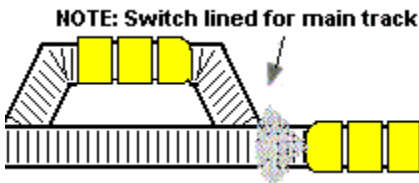

[Diagram A]

- The train is left unattended on the main track in block system limits.

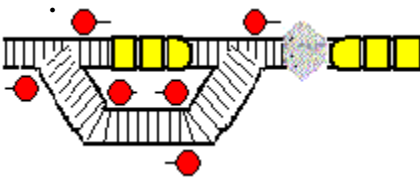

[Diagram B]

**Rule Updated Date**

April 7, 2010

[^Top](#)

**5.9.3: Headlight Failure**

If the headlight on the train fails, ditch lights must be on, when so equipped. Headlight failure must be reported to the train dispatcher.

At night, if the headlight and ditch lights fail to operate and no other unit can be used as the lead unit, continue movement with a white light displayed on the lead unit. Stop the train before each public crossing, so a crew member on the ground can provide warning until the crossing is occupied, unless:

- Crossing gates are in the fully lowered position.  
or
- No traffic is approaching or stopped at the crossing.

**Rule Updated Date**

April 7, 2010

[^Top](#)

### **5.9.4: Displaying Headlights Front and Rear**

When engines are moving, crew members must turn on the headlight to the front and rear, but may dim or extinguish it on the end coupled to cars.

**Rule Updated Date**

April 7, 2010

[^Top](#)

### **5.9.5: Displaying Ditch Lights**

Display ditch lights, if equipped, to the front of the train when moving over public crossings and anytime the headlight is required to be on bright.

Locomotives must not be operated as the lead unit on trains out of the train's initial terminal unless both ditch lights are operating. However, if no units are equipped with ditch lights, do not exceed 20 MPH over public crossings until occupied.

If one ditch light fails enroute, the train may proceed, but repairs must be made by the next daily inspection. If two ditch lights fail enroute, the train may proceed, but not exceeding 20 MPH over public crossings until occupied, but must not travel beyond the first point where repairs may be made or until the next daily inspection, whichever occurs first.

**Application:**

The term "ditch lights" includes oscillating white headlights or strobe lights located on the front of the locomotive. Ditch lights on some foreign locomotives are configured to operate only when the horn is activated. Ditch lights which operate in this manner will be considered as meeting the requirements of this rule. When a remote control locomotive is being controlled with a remote control transmitter, the ditch lights need not be displayed if speed does not exceed 20 MPH. Ditch lights are not required on steam locomotives. Failure of two ditch lights includes employee failure to turn on the ditch lights.

**Rule Updated Date**

May 10, 2019

## **System Special Instructions**

Effective Date: May 10, 2019

[^Top](#)

### **5.9.6: Displaying Oscillating White Headlight**

If the leading engine is equipped with an oscillating white headlight, turn the light on when the engine is moving. However, turn the light off when meeting trains, passing trains, or during switching operations, unless movement involves public crossings at grade.

#### **Rule Updated Date**

April 7, 2010

[^Top](#)

### **5.9.7: Displaying Oscillating or Flashing Red Light**

If the leading engine is equipped with an oscillating or flashing red light, turn the light on under any of the following conditions:

- Train is stopped suddenly where adjacent tracks may be fouled.
- Head-end protection is required.
- or
- Condition exists that endangers movement.

The red light signals an approaching train on the same or adjacent track to stop at once and to proceed only after the track is safe for train passage. Extinguish red flashing lights when they are no longer needed.

Displaying these lights does not modify the requirements of Rule 6.19 (Flag Protection) or Rule 6.23 (Emergency Stop or Severe Slack Action).

#### **Rule Updated Date**

April 7, 2010

[^Top](#)

### **5.9.8: Displaying Cab Roof Light**

If engine is equipped with an amber or white cab roof light that revolves or flashes, display the light on the occupied controlling unit.

#### **Rule Updated Date**

April 7, 2010

[^Top](#)

## **5.10: Markers**

A marker of prescribed type must be displayed on the trailing end of the rear car to indicate the rear of the train.

### **Application:**

Before departing the initial terminal, crew members must know the initials and number of the car that has the marker applied or unit number, when the engine at rear of the train is used as the marker. This can be done verbally by the employee making the initial terminal air brake test, or included on the written notification of the test. If the rear car changes, crew members must record the initials and number of the car having the marker applied before the train departs.

When a train is set out clear of the main track at other than a crew change location, a crew member must remove the End-of-Train (EOT) telemetry device, if so equipped. Transport the EOT on the engine to the destination where the crew is relieved.

If the engine remains with the train, a crew member must deliver the EOT to the proper authority at the tie-up point. However, proper authority may advise the crew to leave the EOT with the train. Always notify the train dispatcher of the location of the EOT.

Do not place an EOT on a locomotive unless it is attached to the coupler. Crew members are responsible to ensure the EOT is placed in the correct location at yards/terminals.

### **Rule Updated Date**

May 10, 2022

### **System Special Instructions**

Effective Date: May 10, 2022

[^Top](#)

### **5.10.1: Highly Visible Markers**

Display a highly visible marker at the rear of every train as follows:

- From 1 hour before sunset to 1 hour after sunrise
- When weather conditions restrict visibility to less than 1/2 mile

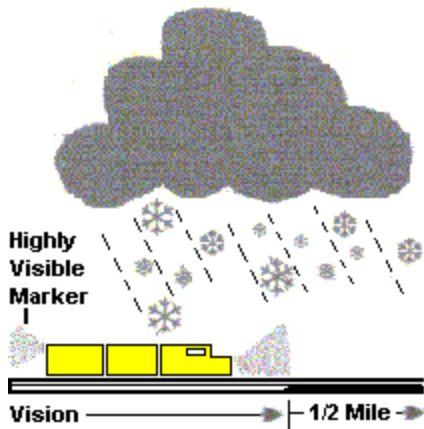

[Diagram A]

A marker equipped with a functioning photo-electric cell will automatically illuminate at the appropriate time.

When an engine is operating without cars or is at the rear of the train, the trailing headlight illuminated on dim may be used as a marker.

### **Inspection of Marker**

When a highly visible marker is required, a qualified employee must inspect it at the initial terminal and at each crew change point. To determine if the marker is functioning properly, the employee will inspect it by observation or by telemetry display in the cab of the engine. The engineer must be informed of the results of the inspection.

### **Rule Updated Date**

April 7, 2010

[^Top](#)

## **5.10.2: Alternative Markers**

Display a reflector, red flag, or light fixture at the rear of the train as the marker when any of the following conditions exists:

- A highly visible marker is not required.
- A defective car must be placed at the rear for movement to a repair point.
- The rear portion of the train is disabled and cannot be moved, and a highly visible marker cannot be displayed on the rear of the portion to be moved.  
or
- The highly visible marker becomes inoperative enroute. If this occurs, notify the train dispatcher and move the train to the next forward location where the highly visible marker can be repaired or replaced.

### **Rule Updated Date**

April 7, 2010

[^Top](#)

## 5.11: Engine Identifying Number

Trains will be identified by initials and engine number. The identifying number will be the number of the lead unit, adding the direction when required. When an engine consists of more than one unit or when two or more engines are coupled, the number of one unit only will be illuminated as the identifying number.

### Exceptions:

- Where PTC is not in effect, the identifying number will be the number of the lead unit, unless changing direction during a trip or tour of duty when that unit is no longer the lead unit.
- Where PTC is in effect, passenger trains operated from a cab control car on the leading end of the movement will be identified by the cab control car initials and number, adding the direction when required.
- On track bulletins that advise about excessive dimension equipment, trains may be identified by train symbol.
- On track bulletins and on track warrants that do not convey movement authority, passenger trains may be identified by schedule number.

### Rule Updated Date

April 5, 2018

### System Special Instructions

Effective Date: April 5, 2018

[^Top](#)

## 5.12: Protection of Occupied Outfit Cars

This rule outlines the requirements for protecting occupied outfit cars. As used in this rule, the following definitions apply:

**Outfit Car.** Any on-track vehicle, including outfit, camp, or bunk car or modular home mounted on a flat car to house railroad employees. Such equipment is not considered an outfit car when placed in a wreck train.

**Effective Locking Device.** When used in relation to a manually operated switch or a derail, a lock that can be locked or unlocked only by the craft or group of workmen applying the lock.

**Rolling Equipment.** Engines, cars and one or more engines coupled to one or more cars.

**Switch Providing Direct Access.** A switch that if used by rolling equipment could permit the rolling equipment to couple to the equipment being protected.

**Warning Signal.** A white sign that reads, "**OCCUPIED CAMP CAR**" in black lettering. At night, an illuminated white light must also be used.

When occupied outfit cars are placed on a track, the employee in charge of the outfit cars occupants (or a designated representative) must provide or request protection using one of the following methods:

## A. On a Main Track

One of these two methods or a combination of these methods must be provided:

1. Each manually operated switch that provides direct access to that portion of the main track where occupied outfit cars are located must be lined against movement to that track, secured with an effective locking device, and spiked or clamped. Warning signals must be displayed at or near each switch.

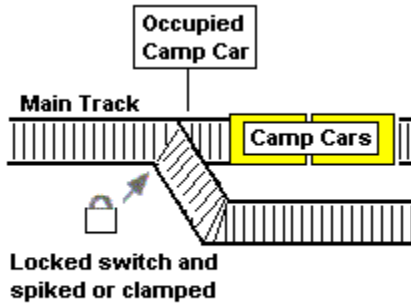

[Diagram A]

2. If remote control switches provide direct access to the main track where occupied outfit cars are located, the control operator will line the switch against movement to that track and apply blocking devices to the control machine to prevent movement onto that track. The control operator must complete the above tasks before informing the employee requesting protection that protection is provided.

**Blocking devices must not be removed until the employee in charge of the outfit car occupants (or a designated representative) informs the control operator that protection is no longer required.**

- a. Warning signals must be displayed at or near each remote control switch.
- b. In addition, a derail capable of restricting access to the portion of main track where occupied outfit cars are located must be placed at least 150 feet from the end of the occupied outfit cars. The derail must be locked in derailing position with an effective locking device. Warning signals must be displayed at each derail.
- c. The control operator must maintain for 15 days a written record of each notification. The record must contain the following information.
  - Name and craft of employee requesting protection.
  - Identification of track protected.
  - Date and time employee in charge of outfit car occupants is notified that protection was provided.
  - Date, time, name and craft of employee authorizing removal of protection.



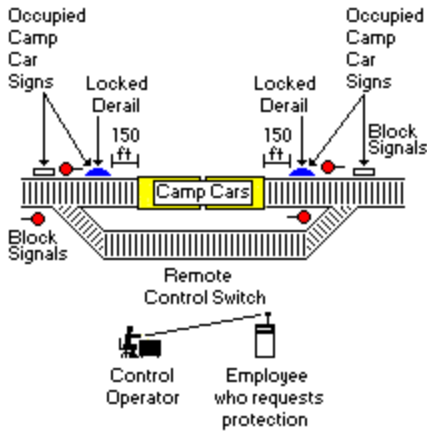

[Diagram B]

## B. On other than a Main Track

One of these three methods of protection or a combination of these methods must be provided

1. Each manually operated switch that provides direct access to the track where occupied outfit cars are located must be lined against movement to that track and secured with an effective locking device. Warning signals must be displayed at or near each switch.

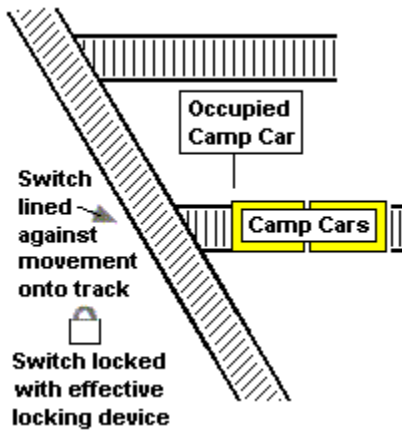

[Diagram C]

- 2 If remote control switches provide direct access to the track where occupied outfit cars are located, the control operator
  - will line the switch against movement to that track and apply blocking devices to the control machine to prevent movement onto that track. The control operator must complete the above tasks before informing the employee requesting protection that protection is provided.

**Blocking devices must not be removed until the employee in charge of the outfit car occupants (or a designated representative) informs the control operator that protection is no longer required.**

- a Warning signals must be displayed at or near each remote control switch.

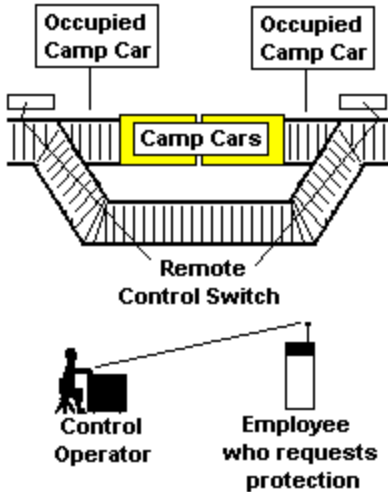

[Diagram D]

- b The control operator must maintain for 15 days a written record of each notification. The record must contain the following information:
    - Name and craft of employee requesting protection
    - Identification of track protected
    - Date and time employee in charge of outfit cars occupants is notified that protection was provided.
    - Date, time, name and craft of employee authorizing removal of protection.
- 3 A derail capable of restricting access to that portion of the track where occupied outfit cars are located will fulfill the requirements of protection when the derail is:
- a Positioned at least 150 feet from the end of the occupied outfit cars.
    - or
  - b Positioned at least 50 feet from the end of the occupied outfit cars where the maximum speed on that track is 5 MPH.

Warning signals must be displayed at each derail.

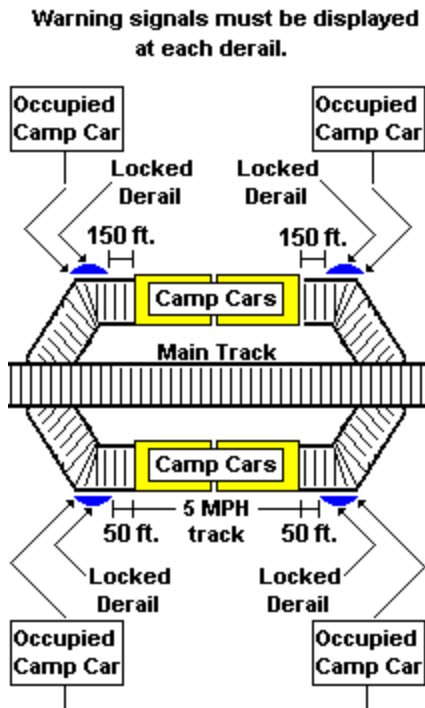

[Diagram E]

### C. Warning Signals

When a warning signal is displayed to protect occupied outfit cars:

1. Occupied outfit cars must not be coupled to or moved.
2. Rolling equipment must not pass the warning signal.
3. Rolling equipment must not be placed on the same track in a manner that would block or reduce the crew's view of the warning signal.

#### Rule Updated Date

April 7, 2010

[^Top](#)

### 5.13: Blue Signal Protection of Workmen

This rule outlines the requirements for protecting railroad workmen who are inspecting, testing, repairing, and servicing rolling equipment. In particular, because these tasks require the workmen to work on, under or between rolling equipment, workmen are exposed to potential injury from moving equipment.

As used in this rule, the following definitions apply:

**WORKMEN.** Railroad employees assigned to inspect, test, repair, or service railroad equipment or components, including brake systems. Train and yard crews are excluded, except when they perform the above work on rolling equipment not part of the train or yard movement they are handling or will handle.

- "Servicing" does not include supplying cabooses, engines, or passenger cars with items such as ice, drinking water, tools, sanitary supplies, stationery, or flagging equipment.
- "Testing" does not include an employee making visual observations while on or alongside a caboose, engine, or passenger car. Also, testing does not include repositioning the activation switch or covering the photo-electric cell of the marker when the rear of the train is on the main track. The employee inspecting the marker must contact the employee controlling the engine to confirm that the train will remain secure against movement until the inspection is complete.

**GROUP OF WORKMEN.** Two or more workmen of the same or different crafts who work as a unit under a common authority and communicate with each other while working.

**ROLLING EQUIPMENT.** Engines, cars, and one or more engines coupled to one or more cars.

**BLUE SIGNAL.** During the day, a clearly distinguishable blue flag, or light, and at night, a blue light. The blue light may be steady or flashing.

The blue signal does not need to be lighted when it is attached to the operating controls of an engine and the inside of the engine cab area is lighted enough to make the blue signal clearly distinguishable.

**EFFECTIVE LOCKING DEVICE.** When used in relation to a manually operated switch or derail, a lock that can be locked or unlocked only by the craft or group of workmen applying the lock.

**CAR SHOP REPAIR AREA.** One or more tracks within an area where rolling equipment testing, servicing, repairing, inspecting, or rebuilding is controlled exclusively by mechanical department personnel.

**ENGINE SERVICING AREA.** One or more tracks within an area where engine testing, servicing, repairing, inspecting, or rebuilding is controlled exclusively by mechanical department personnel.

**SWITCH PROVIDING DIRECT ACCESS.** A switch that if used by rolling equipment could permit the rolling equipment to couple to the equipment being protected.

### **A. What a Blue Signal Signifies**

A blue signal signifies that workmen are on , under, or between rolling equipment and requires that:

1. Rolling equipment must not be coupled to or moved, except as provided in "Movement in Engine Servicing Area" and "Movement in Car Shop Repair Area" of this rule.
2. Rolling equipment must not pass a blue signal on a track protected by the signal.
3. Other rolling equipment must not be placed on the same track so as to block or reduce the view of the blue signal.
  - a However, rolling equipment may be placed on the same track when it is placed on designated engine servicing area . tracks or car shop repair area tracks, or when a derail divides a track into separate working areas.
4. Rolling equipment must not enter a track when a blue signal is displayed at the entrance to the track.
5. Controls or devices on rolling equipment that could effect movement (for example, MU cables/hoses, hand brakes, angle cocks, etc.) must not be changed or operated unless directed by individuals who placed the blue signals or by the employee in charge of workmen.

Blue signals or remote control blue signals must be displayed for each craft or group of workmen who will work on, under, or between rolling equipment.

**Protection Removed.** Blue signals may be removed only by the craft or group who placed them. Remote control display may be discontinued when directed by the craft or group that requested the protection. When blue signal protection has been removed from one entrance of a double-ended track or from either end of rolling equipment on a main track, that track is no longer under blue signal protection.

## B. How to Provide Protection

When workmen are on, under, or between rolling equipment and exposed to potential injury, protection must be provided as follows:

**On a Main Track.** A blue signal must be displayed at each end of the rolling equipment.

**On Other than a Main Track.** One of these three methods of protection or a combination of these methods must be provided:

- 1 Each manually operated switch, including any facing point crossover switch that provides direct access must be lined . against movement onto the track and secured by an effective locking device. A blue signal must be placed at or near each such switch.

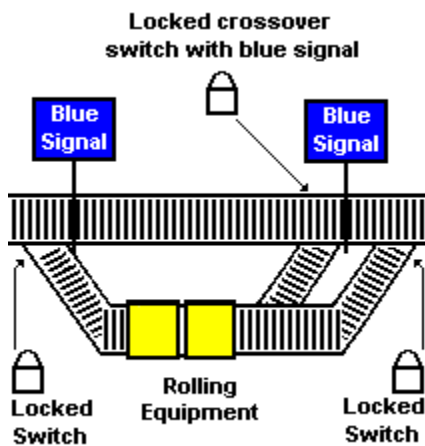

[Diagram A]^^^

- 2 A derail capable of restricting access to the track where work will occur must be locked in derailing position with an . effective locking device and:
  - a 150 feet from the rolling equipment to be protected.
    - . or
  - b 50 feet from the end of rolling equipment on a designated engine servicing track or car shop repair track where . speed is limited to not more than 5 mph. A blue signal must be displayed at each derail.

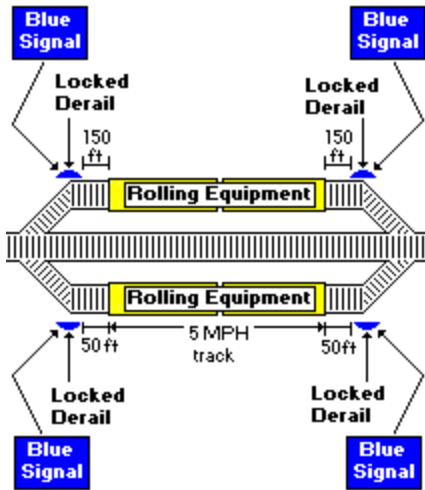

[Diagram B]^^^

- 3 Where remote control switches provide direct access, the employee in charge of the workmen must tell the switch operator what work will be done. The switch operator must then:
- a Inform the employee in charge of the workmen that the switches have been lined against movement onto the track and devices controlling the switches have been secured.
  - b Not remove the locking devices unless the employee in charge of the workmen says it is safe to do so.
  - c Maintain for 15 days a written record of each notification that includes:
    - Name and craft of the employee in charge of the workmen requesting protection
    - Identification of track involved
    - Date and time the employee in charge of workmen is notified that protection was provided
    - Date, time, name, and craft of the employee in charge of workmen who authorized removal of the protection

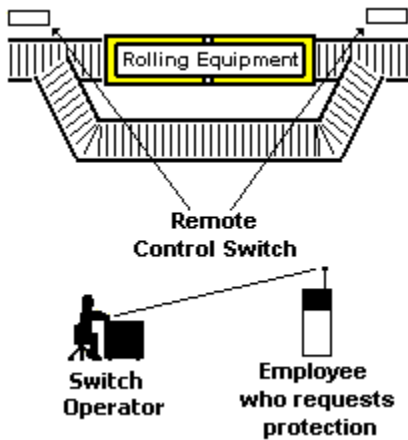

[Diagram C]^^^

### C. Blue Signal Readily Visible to Engineer

In addition to providing protection as required in On a Main Track and On Other than a Main Track, when workmen are on, under, or between an engine or rolling equipment coupled to an engine.

1. A blue signal must be attached to the controlling engine and be visible to the engineer or employee controlling the engine.
2. Engines equipped for remote control operations must be in manual. A blue tag must be placed on the switch governing remote/manual operation.
3. The engine must not be moved.
4. Engine controls, brakes, circuit breakers and electrical switches (except cab lights) must not be operated unless directed by individuals who placed the blue signals or by the employee in charge of workman.

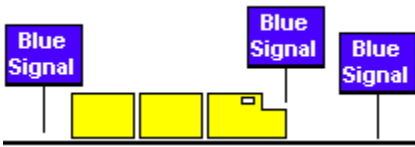

[Diagram D]^^

Note:

Remote control locomotives may be in remote mode while under blue signal protection to service remote control locomotive equipment/functions when the following requirements are met:

1. The employee placing the locomotive in remote mode has been trained to repair and operate remote control equipment.
2. All employees involved on the unit and/or tracks are job briefed and warned against possible inadvertent movement of the locomotive.

When a blue signal is attached to an engine, unless directed by the craft who place the blue signal, changing controls, brake settings, turning on or off switches (except overhead cab lights) or circuit breakers or starting or shutting down the engine is prohibited.

#### **D. Protection for Workmen Inspecting Markers**

Blue signal protection must be provided for workmen when they are:

- 1 Replacing, repositioning, or repairing a marker, and the rear of the train is on any track.
  - . or
- 2 Inspecting a marker by repositioning the activation switch or covering the photo-electric cell, and the rear of the train is
  - . on other than a main track.

#### **E. Protection for Emergency Repair Work on a Main Track**

If a blue signal is not available for employees performing emergency repairs on, under, or between an engine or rolling equipment coupled to an engine, the employee controlling the engine must be notified and appropriate measures taken to provide protection for the employees.

#### **F. Movement in Engine Servicing Area**

An engine must not enter a designated engine servicing area until the blue signal protection is removed from the entrance. The engine must stop short of coupling to another engine.

An engine must not leave a designated engine servicing area unless the blue signal is removed from the engine and the track in the direction of movement.

Blue signal protection removed to let engines enter or leave the engine servicing area must be restored immediately after the engine enters or clears the area.

An engine protected by blue signals may be moved on a designated engine servicing area track when:

- 1 An authorized employee operates the engine under the direction of the employee in charge of workmen.
- 2 The blue signal has been removed from the controlling engine to be repositioned.
- 3 Workmen have been warned of the movement.
- 

## **G. Movement in Car Shop Repair Area**

When rolling equipment on car shop repair tracks is protected by blue signals, a car mover may reposition the equipment if:

- 1 Workmen have been warned of the movement.
- 2 An authorized employee operates the car mover under the direction of the employee in charge of workmen.
- **Rule Updated Date**

April 1, 2015

### **System Special Instructions**

Effective Date: April 1, 2015

[^Top](#)

## **5.13.1: Utility Employees**

This rule outlines the requirements for allowing utility employees to work without blue signal protection. As used in this rule, a Utility Employee is a railroad employee assigned as a temporary member of a train or yard crew.

### **A. Requirements to Start Work**

A utility employee may work as a member of only one train or yard crew at a time. No more than three utility employees may work with one train or yard crew at the same time.

A utility employee may become a member of a train or yard crew under the following conditions:

- The utility employee communicates with the designated crew member of the train or yard crew before starting work. Communication may be conducted verbally or by radio.
- The designated crew member identifies the utility employee to each member of the crew, and each crew member acknowledges the utility employees presence.
- The designated crew member authorizes the utility employee to work as a temporary member of the crew.

### **B. Requirements While Working On, Under, or Between**



Before a utility employee may work on, under, or between rolling equipment, the following applies:

- All members of the crew must communicate with each other to understand the work to be done.
- The engineer must be in the cab of the assigned controlling locomotive. However, another member of the same crew may replace the engineer when the locomotive is stationary.

### **C. Requirements When Work Ends**

A utility employee is released from a train or yard crew when:

- The utility employee notifies the designated crew member that the work is completed.
- The designated crew member notifies each crew member that the utility employee is being released.
- The designated crew member releases the utility employee from the train or yard crew, after each crew member acknowledges this notice.

#### **Rule Updated Date**

April 7, 2010

[^Top](#)

## **5.14: Signs Protecting Equipment**

When a sign reading:

**STOP -- TANK CAR CONNECTED**

**STOP -- MEN WORKING**

**EMPLOYEES WORKING**

**SERVICE CONNECTIONS**

or a similar warning is displayed on a track or car, the car must not be coupled to or moved. Other equipment must not be placed on the same track in a manner that would block or reduce the view of the sign.

#### **Rule Updated Date**

April 7, 2010

[^Top](#)

### **5.14.1: Contractor Protection for Servicing Locomotives**

When contractors are working, on, under, or between equipment, the contractor will place a red flag in a location that can be clearly seen from the cab of the controlling engine. When employees take charge of an engine, they must visually determine if a red flag is displayed. When a red flag is attached to an engine, unless directed by the contractor, the following are prohibited:

- Changing controls or brake settings.
- Turning on or off switches (except overhead cab lights).
- Changing circuit breakers.
- Starting or shutting down the engine.

#### **Rule Updated Date**

July 1, 2015

#### **System Special Instructions**

Effective Date: July 1, 2015

[^Top](#)

### **5.15: Improperly Displayed Signals**

If a signal is improperly displayed, or a signal, flag, or sign is absent from the place it is usually shown, regard the signal as displaying the most restrictive indication it can give. However, if a semaphore arm is visible, it will govern.

Promptly report improperly displayed signals or absent fixed signals, flags, or signs to the train dispatcher.

#### **Rule Updated Date**

April 7, 2010

[^Top](#)

## Union Pacific Rules

### UPRR - General Code of Operating Rules

## **6.0: MOVEMENT OF TRAINS AND ENGINES**

- [6.1: Repeat Instructions](#)
- [6.2: Initiating Movement](#)
- [6.2.1: Train Location](#)
- [6.3: Main Track Authorization](#)
- [6.3.1: Train Coordination](#)
- [6.4: Reverse Movements](#)
- [6.4.1: Permission for Reverse Movement](#)
- [6.4.2: Movements Within Control Points or Interlockings](#)
- [6.5: Shoving Movements](#)
- [6.5.1: Remote Control Movements](#)
- [6.5.2: Movement of Light Remote Control Locomotive](#)
- [6.6: Back Up Movements](#)
- [6.7: Remote Control Zone](#)
- [6.8: Stopping Clear for Meeting or Passing](#)
- [6.9: Meeting or Passing Precautions](#)
- [6.10: Instructions to Clear a Following Train](#)
- [6.11: Mandatory Directive](#)
- [6.12: FRA Excepted Track](#)
- [6.13: Yard Limits](#)
- [6.14: Restricted Limits](#)
- [6.15: Block Register Territory](#)
- [6.16: Approaching Railroad Crossings, Drawbridges, and End of Multiple Main Track](#)
- [6.17: Switches at Junctions](#)
- [6.18: Stopping Clear of Crossings and Junctions](#)
- [6.19: Flag Protection](#)
- [6.20: Equipment Left on Main Track](#)
- [6.21: Precautions Against Unusual Conditions](#)
- [6.21.1: Protection Against Defects](#)
- [6.21.2: Water Above Rail](#)
- [6.21.3: Track Obstruction/Unusual Conditions](#)
- [6.22: Maintaining Control of Train or Engine](#)
- [6.23: Emergency Stop, Severe Slack Action, or Actuation of a Shifted Load or Dragging Equipment Detector](#)
- [6.24: Movement on Double Track](#)

- [6.25: Movement Against the Current of Traffic](#)
- [6.26: Use of Multiple Main Tracks](#)
- [6.27: Movement at Restricted Speed](#)
- [6.28: Movement on Other than Main Track](#)
- [6.28.1: Sidings of Assigned Direction](#)
- [6.28.2: Stopping Clear in Siding](#)
- [6.28.3: Cars or Equipment Left on Siding](#)
- [6.29: Inspecting Trains](#)
- [6.29.1: Inspecting Passing Trains](#)
- [6.29.2: Train Inspections by Crew Members](#)
- [6.30: Receiving or Discharging Passengers](#)
- [6.31: Maximum Authorized Speed](#)
- [6.31.1: Permanent Speed Restrictions](#)
- [6.32: Crossings](#)
- [6.32.1: Providing Warning Over Crossings](#)
- [6.32.2: Crossing Warning Devices \(Highway/Pathway - Rail Grade Crossings\)](#)
- [6.32.3: Providing Warning for Adjacent Tracks](#)
- [6.32.4: Clear of Crossings and Signal Circuits](#)
- [6.32.5: Actuating Automatic Warning Devices Unnecessarily](#)
- [6.32.6: Blocking Public Crossings](#)
- [6.32.7: Road Crossings within Intermodal and Automotive Facilities](#)

## **6.1: Repeat Instructions**

An employee who verbally receives instructions or information about train or engine movements must repeat them.

### **Rule Updated Date**

April 7, 2010

[^Top](#)

## **6.2: Initiating Movement**

Before initiating movement on a main track or controlled siding, a crew member must:

- Receive track bulletins affecting their movement.
- or
- Determine from the train dispatcher or yardmaster if any track bulletins are needed.

When operating with a Track Condition Summary (TCS), and the PTC System is NOT in the ACTIVE or DISENGAGED state (including operating in non-PTC territory or operating per Rule 18.13), a crew member must contact the train dispatcher to verify TCS is operative. Verification may occur before or after departure.

**Rule Updated Date**

April 30, 2024

**System Special Instructions**

Effective Date: May 5, 2021

**General Order**

Effective Date: April 30, 2024

[^Top](#)

**6.2.1: Train Location**

Trains who receive authority to occupy the main track after the arrival of a train or to follow a train, must ascertain the train's location by one of the following methods:

- Direct communication with a crew member of the train.
- or
- Receiving information about the train from the train dispatcher or control operator.

**Rule Updated Date**

April 1, 2015

**System Special Instructions**

Effective Date: April 1, 2015

[^Top](#)

**6.3: Main Track Authorization**

Do not occupy main tracks unless authorized by one of the following:

- Rule 6.13 (Yard Limits).
- Rule 6.14 (Restricted Limits).
- Rule 6.15 (Block Register Territory).
- Rule 9.14 (Movement with the Current of Traffic).
- Rule 9.14.2 (Controlled Block System CBS).

- Rule 9.15 (Track Permits).
- Rule 10.1 (Authority to Enter CTC).
- Rule 14.1 (Authority to Enter TWC).
- Rule 14.6 (Movement Against the Current of Traffic).
- Rule 15.3 (Authorizing Movement Against the Current of Traffic).
- Rule 15.4 (Protection When Tracks Removed from Service).
- Rule 16.1 (Authority to Enter DTC).
- At manual interlockings, authority from the control operator or a controlled signal that indicates proceed.
- Special instructions or general order.

When unable to obtain authority and it is necessary to foul or occupy a main track in ABS, protection must be provided in both directions as outlined under Rule 9.17.1 (Signal Protection in ABS by Lining Switch).

Written authorities that are no longer in effect must be retained until the end of tour of duty, unless otherwise instructed by the train dispatcher.

### **Joint Authority**

When a train or employee receives authority joint with an employee(s), the train or employee must not occupy the overlapping limits until:

- Working limits are described and permission is received to enter the overlapping limits from the employee(s) listed on the authority. When possible, attempt to obtain permission must be made at least 2 miles in advance of the limits.  
or
- Advice is received from the train dispatcher or control operator that the employee(s) have reported clear of the limits.

When a train receives joint authority, movements must be made at restricted speed.

### **Rule Updated Date**

May 5, 2021

### **System Special Instructions**

Effective Date: May 5, 2021

[^Top](#)

## **6.3.1: Train Coordination**

Train Coordination provides for men or equipment to use a train's authority to establish working limits. The employee must contact the train's engineer to request use of Train Coordination.

To establish working limits:

- The train must be in view and stopped.
- The employee in charge of working limits will communicate with the engineer who will notify other crew members that working limits are to be established.

- The engineer will make movements only as permitted by the employee in charge until the working limits have been released to the engineer.
- The train will not release its authority within the limits until those working limits have been released by the employee in charge.

## **Establish Working Limits**

Working limits may be established within a train's authority limits as follows:

### **A. DTC or TWC Territory**

1. With a train having authority to move in either direction that is not joint.  
or
2. With a train having authority to move in one direction only, working limits must not be established:
  - Behind the train.
  - More than one block in advance of the train or beyond any location that a train or engine could enter the track between the employee in charge of the working limits and the train.

### **B. Rule 9.15 (Track Permit)**

With a train having the only track permit authority within the limits.

### **C. Rule 9.14 (Current of Traffic)**

With a train having authority to move with the current of traffic, working limits must not be established:

- Behind the train.
- More than one block in advance of the train or beyond any location that a train or engine could enter the track between the employee in charge of the working limits and the train.

### **D. CTC Territory**

1. With a train having track and time authority that is not joint.  
or
2. With a train having authority to move in one direction only, working limits must not be established:
  - Behind the train.
  - More than one block in advance of the train or beyond any location that a train or engine could enter the track between the employee in charge of the working limits and the train.

### **Rule Updated Date**

April 7, 2010

[^Top](#)

## **6.4: Reverse Movements**

Make reverse movements on any main track, controlled siding, or on any track where a block system is in effect at restricted speed and only within the limits a train has authority to occupy the track.

**Rule Updated Date**

April 7, 2010

[^Top](#)

## **6.4.1: Permission for Reverse Movement**

Obtain permission from the train dispatcher or control operator before making a reverse movement, unless the movement is within the same signaled block.

When a train or engine is advised that working limits have been established behind their train, obtain permission from the employee in charge to make any reverse movements, including within the same signaled block.

**Rule Updated Date**

July 11, 2023

**System Special Instructions**

Effective Date: July 11, 2023

[^Top](#)

## **6.4.2: Movements Within Control Points or Interlockings**

### **A. Control Points or Manual Interlockings**

**Control Points Outside Manual Interlockings.**

Except within track and time limits, if movement stops while the trailing end is between the outer opposing absolute signals of a control point, the movement must not change direction without permission from the control operator. However, after a job briefing has been conducted and the control operator has a clear understanding of all movements to be made and tracks to be used, the control operator may grant permission for all movements.

**Manual Interlockings**

If movement stops while the trailing end is between the outer opposing absolute signals of a manual interlocking, the movement must not change direction without permission from the control operator.

### **B. Automatic Interlockings**

At an automatic interlocking, the train movement may change direction within the limits of the interlocking if it continuously occupies at least one car length of the limits.

**Rule Updated Date**



April 1, 2015

## System Special Instructions

Effective Date: April 1, 2015

[^Top](#)

## 6.5: Shoving Movements

### Providing Protection Prior to Initiating Shoving Movement

Equipment must not be shoved until it is visually determined that:

- Portion of track to be used is clear of equipment or conflicting movements.
- The track will remain clear to the location where movement will be stopped.
- Switches and derails are properly lined.

Engineer and employee protecting the movement must complete a job briefing concerning how protection will be provided.

When not using hand signals, radio job briefing must include:

- Who will protect the shove.
- How the shove will be protected.
- Distance and direction to be shoved (Distance specified must be acknowledged when it is more than four cars.)

### **MOVEMENT MUST STOP WITHIN HALF THE DISTANCE SPECIFIED UNLESS ADDITIONAL INSTRUCTIONS ARE RECEIVED.**

Employee directing movement must provide visual protection for the equipment being shoved and must not turn their back on the movement when fouling, walking near, or crossing tracks. Participating employees must not engage in unrelated tasks during the shoving movement.

Shoving movements over road crossings must be made in accordance with Rule 6.32.1 (Providing Warning Over Crossings).

Employees may be relieved from providing visual protection when:

- Superintendent Bulletin specifies tracks that will be protected with shove lights or monitored cameras.
- Making back up movements in accordance with Rule 6.6 (Back up Movements).
- A track has been pulled and cars or equipment of less length will be immediately shoved back into the track and it is visually determined the track has remained clear to the location where movement will be stopped.

### Speeds When Shoving

When cars are shoved on a main track or controlled siding in the direction authorized, movement must not exceed:

- 20 MPH for freight trains.
- 30 MPH for passenger trains.

- Maximum timetable speed for snow service unless the employee in charge authorizes a higher speed.

### **Rule Updated Date**

December 1, 2023

### **System Special Instructions**

Effective Date: January 24, 2024

### **General Order**

Effective Date: December 1, 2023

[^Top](#)

## **6.5.1: Remote Control Movements**

Remote control movements are considered shoving movements, except when the remote control operator controlling the movement is riding the leading locomotive in the direction of movement. Before initiating movement, the remote control operator or a crew member must be in position to visually observe the direction the equipment moves.

When approaching within 200 feet of a fouling point, switch, or derail, employee controlling the movement must be on the point of the movement outside the cab when riding the locomotive. However, movement may be controlled from inside the cab of the lead locomotive when:

- Operating in severe weather conditions such as high winds, hail, heavy rain or snowfall, extreme cold/heat, or when advised of tornado or thunderstorm warning.  
or
- It is necessary to sound the whistle.

When operating in pitch and catch mode and making a shoving movement, the primary operator must be in position to protect the point of movement.

**Exception:** After conducting a job briefing with the employee who will be protecting the point, the primary operator is not required to pitch control when:

- Stretching a track to ensure couplings are made.  
or
- Separating equipment to make coupler adjustments.

When requesting pin slack, the employee uncoupling the equipment is not required to be the primary operator.

### **Relief of Providing Protection**

The remote control operator is relieved from providing protection and the requirement to stop within half the range of vision for movements with engine on leading end when:

1. The remote control zone has been activated.
  2. The remote control zone has been properly verified / swept to determine:
    - Switches / derails are known to be properly lined.
    - Track(s) within the zone are known to be clear of other trains, engines, railroad cars, and men or equipment fouling track.  
and
    - Pull back / stop protection (PSP) is operational by traversing at least one puck and observing the activation on the OCU when equipped with PSP.
- \* Pull back and stop protection must again be verified if PSP is overridden or disabled.

**Note: These steps must be repeated each time the remote control zone is activated.**

- 3 Pulling out of a track directly connected to an activated zone and all switches traversed are included in the zone. Bell . must be sounded continuously until locomotive occupies activated zone track.

#### **Rule Updated Date**

March 1, 2024

#### **System Special Instructions**

Effective Date: May 10, 2019

#### **General Order**

Effective Date: March 1, 2024

[^Top](#)

## **6.5.2: Movement of Light Remote Control Locomotive**

Unless relieved of providing protection, the primary operator must take a position on the leading end of a light remote control locomotive consist or be positioned on the ground clear of the movement and able to observe the entire movement before initiating the movement.

#### **Rule Updated Date**

April 1, 2015

#### **System Special Instructions**

Effective Date: April 1, 2015

[^Top](#)

## 6.6: Back Up Movements

After obtaining permission from the train dispatcher, a train may back up on any main track or on any track where CTC is in effect under the following conditions:

1. The crew ensures movement will not:
  - a) Exceed the limit of the train's authority.
  - b) Exceed the train's length.
  - c) Enter or foul a private or public crossing except as provided by Rule 6.32.1 (Providing Warning Over Road Crossings).
  - d) Be made into or within yard limits, restricted limits, interlocking limits, drawbridges, railroad crossings at grade, or track bulletin Form B limits.
  
2. The train dispatcher grants permission to make the movement after verifying the following within the same or overlapping limits:
  - a) Another authority is not in effect unless conflicting movements are protected.
  - b) A track bulletin Form B is not in effect.
  - c) The main track is not removed from service.
  - d) Track Breach Protection is not in effect.
  - e) Permission to leave a switch in the reverse position has not been granted.

When movement is made under these conditions, restricted speed does not apply.

Before a crew requests and makes a move under this rule, a job safety briefing between crew members must be conducted that includes:

- Confirmation of authority limits.
- Location of nearest affected road crossings in direction of movement.
- Distance to be shoved.
- Confirmation that train is intact, verified either visually or by determining that brake pipe continuity exists using EOT device or distributed power telemetry.

### Rule Updated Date

June 1, 2017

### System Special Instructions

Effective Date: June 1, 2017

[^Top](#)

## 6.7: Remote Control Zone

### A. Entering Remote Control Zone

Before entering a remote control zone, all employees that are not part of the remote control crew must determine whether the zone is activated. Employees may receive this information from the remote control operator, other authorized employee, or special instructions.

When the remote control zone is activated, track(s) within the zone must not be fouled with equipment, occupied, or switches operated until the remote control zone has been deactivated or permission is granted by the remote control operator to enter the remote control zone.

Protection must be provided while other employees are in the remote control zone. The remote control operator must know the track is clear and switches are properly lined after other employees are clear of the remote control zone.

#### **Application of part A. Entering Remote Control Zone:**

Timetable special instructions will designate limits of remote control zones. Signs will be posted at access locations to remote control zones. When an RCL movement makes a pullout move from a directly connected track into an activated zone, zone limits include the track between the leading end of the locomotive and the activated zone when all switches traversed are included in the zone. Remote control zone limits do not include tracks within CTC or interlocking limits (CTC or interlocking rules apply). Only the remote control operator may activate a zone. However, timetable special instructions may designate the hours a zone is active. Proper records must be maintained concerning activation, deactivation and transfer of the zones at locations where a designated supervisor may be contacted to determine if a zone is active.

Record must include:

- Job designation.
- Zone number.
- Date and time zone activated.
- If applicable, time zone transferred and job designation of other remote control job. Transfers from one job to another do not need to be recorded unless the transfer involves a job that is going off duty or will not again control the active zone. All active zones must be transferred to a new zone log.
- Date and time zone deactivated.

Remote control operators may allow only one other train or engine movement to occupy the limits of their active zone at one time. When that train or engine is clear of the zone with switches properly lined, it must report directly to the remote control operator. If it is necessary for other train or engine movements to enter the limits of the active zone during that time, the zone must be deactivated.

Engineering employees may use Individual Train Detection (ITD) in an active Remote Control Zone, when performing work without equipment. A job briefing must take place between the RCO and the engineering employee. The job briefing must include one of these options:

- Remote control movements will stop until the engineering employee completes the task and reports clear.  
or
- RCO must provide protection for all movements.

Engineering or mechanical department employees, with equipment, must not enter or foul the track within an active zone. If necessary to enter the zone limits, the zone must be deactivated.

#### **B. Transfer of an Active Remote Control Zone**

An active remote control zone may be transferred to other remote control operators. A job briefing must be conducted each time the zone is transferred between remote control operators and, if applicable, other authorized employee.

After a zone equipped with pull back / stop protection (PSP) is transferred from a job that is going off duty, the relieving crew must verify PSP is operational by traversing at least one puck and observing the activation on the OCU at the first practical time after the start of each shift, but not more than 2 hours after start of that shift.

Refer to Rule 35.4.2 Remote Control Transmitter Testing, part B, when linked RCTs are transferred.

### C. Deactivating Remote Control Zone

When the remote control operator ends the tour of duty, the remote control zone must be deactivated except the remote control zone may remain active if:

- Transferred.  
or
- Special instructions specify the hours the remote control zone is active.

#### Rule Updated Date

September 22, 2022

#### System Special Instructions

Effective Date: July 11, 2023

[^Top](#)

## 6.8: Stopping Clear for Meeting or Passing

A train that may be met or passed must stop at least 400 feet from the signal or clearance point of the facing point switch the other train will pass over, if length of train permits.

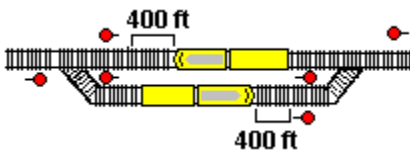

[Diagram A]

#### Rule Updated Date

April 7, 2010

[^Top](#)

## 6.9: Meeting or Passing Precautions

A train required to take siding must stop clear of the switch, unless the switch is properly lined to leave the main track.

A train standing on the main track to meet an opposing train must, if possible, line the switch for the opposing train to leave the main track. However, within ABS, do not line the switch until the opposing train has entered the block in advance.

**Rule Updated Date**

April 7, 2010

[^Top](#)

## **6.10: Instructions to Clear a Following Train**

If the train dispatcher instructs a train within block system limits to clear a following train, the train must be in the clear before the following train could receive a restrictive signal indication.

Determine the location of the following train by radio or other means of communication.

**Rule Updated Date**

April 7, 2010

[^Top](#)

## **6.11: Mandatory Directive**

Mandatory directives are written, printed, or displayed authorities or speed restrictions issued by the train dispatcher or control operator. Mandatory directives are:

- Track warrants.
- Track bulletins.
- DTC authority.
- Track and time.
- Track permits.
- Radio speed restrictions.

A mandatory directive restricting a train's movement will not be issued near a point where the restriction applies until the engineer or conductor confirms that the train can comply with the restriction.

Indicate "VOID" on mandatory directive form when:

- Employee reports clear of authority limits,

or

- Mandatory directive is made void

Crew must retain mandatory directives for continuous tour of duty.

**Rule Updated Date**

April 7, 2010

[^Top](#)

## 6.12: FRA Excepted Track

On a track designated as "FRA Excepted Track" the following will govern:

- Maximum speed must not exceed 10 MPH.
- No occupied passenger train will be operated.
- No movement will be operated that contains more than five cars placarded according to Hazardous Material Regulations.

### Rule Updated Date

April 7, 2010

[^Top](#)

## 6.13: Yard Limits

Within yard limits, trains or engines are authorized to use the main track not protecting against other trains or engines. Engines must give way as soon as possible to trains as they approach. Engines must keep posted as to the arrival of passenger trains and must not delay them.

All movements entering or moving within yard limits must be made at restricted speed unless operating under a block signal indication that is more favorable than Approach.

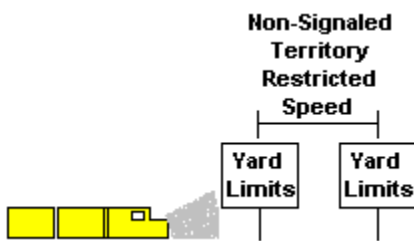

[Diagram A]^

Upon observing or having advance knowledge that a block signal may require restricted speed due to yard limits, if entering or within yard limits, the movement must be at restricted speed at that block signal, or as soon as possible thereafter, consistent with good train handling.

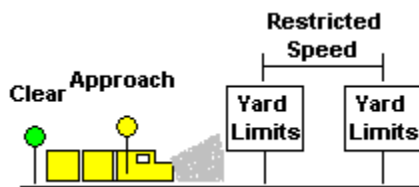

[Diagram B]^



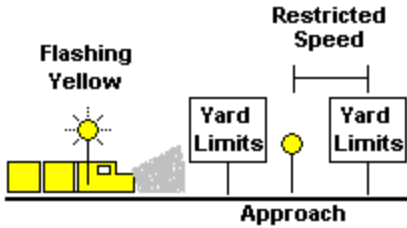

[Diagram C]^

Yard limits remain in effect continuously unless otherwise specified by special instructions or track bulletin.

### Against the Current of Traffic

Movements against the current of traffic must not be made unless authorized or protected by track warrant, track bulletin, yardmaster, or other authorized employee.

### In CTC Territory

Where yard limits are in effect in CTC territory, the control operator must authorize any movement on the main track. Reverse movements within the same block may be made as outlined in Rule 6.4.1 (Permission for Reverse Movements).

### In Track Permit Territory

Where yard limits are in effect in Rule 9.15 (Track Permit) territory, all movements must receive permission from the control operator to enter the main track or to cross over from one main track to another as follows:

- A controlled signal displays a proceed indication;
- A track permit is issued;

or

- Verbal permission is granted if no track permit is in effect. Rule 9.17 (Entering Main Track at Hand Operated or Spring Switch) applies.

### Rule Updated Date

April 1, 2015

[^Top](#)

## 6.14: Restricted Limits

Within restricted limits, trains or engines are authorized to use the main track not protecting against other trains or engines. All movements must be made at restricted speed.

Movements against the current of traffic must not be made unless authorized or protected by track warrant, track bulletin, yardmaster, or other authorized employee.

### Rule Updated Date

April 1, 2015

[^Top](#)

## 6.15: Block Register Territory

Block register territory will be designated in the special instructions. A register labeled "Block Register Territory" will apply only on that designated territory. A train or employee in charge of men or equipment is authorized to occupy block register territory under the following conditions:

- The following information is in the register on the first blank line:

TRAIN, GANG, OR EQUIPMENT IDENTIFICATION	CONDUCTOR OR EMPLOYEE IN CHARGE OF MEN OR EQUIPMENT	DATE	TIME TERRITORY OCCUPIED	TIME TERRITORY CLEARED
A	B	C	D	E

COLUMN	REQUIRED ENTRY
A.....	Enter the train, gang, or equipment identification.
B.....	Enter last name of conductor or employee in charge of men or equipment.
C.....	Enter current date.
D.....	Enter time entry is made in register.
E.....	Enter time the territory was cleared. Then, draw a line through the entire entry. The required exit entry may be completed by any authorized employee.

- If the register indicates the territory is occupied, entry cannot be made on the register until the employee in charge or engineer of each preceding entry has been contacted. When the territory is jointly occupied, movements must be made at restricted speed.

### Rule Updated Date

April 7, 2010

[^Top](#)

## 6.16: Approaching Railroad Crossings, Drawbridges, and End of Multiple Main Track

Trains and engines must be prepared to stop when they approach railroad crossings at grade, drawbridges, and the end of multiple main track, unless these areas are protected by block or interlocking signals.

### Protected by Stop Signs

If stop signs protect these areas, the train must stop before any part of the train or engine passes the stop sign. The train cannot proceed until the route is clear or drawbridge position permits movement.

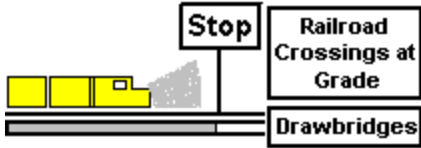

[Diagram A]

### Protected by Gate

If a gate is lined against the intended route, trains and engines must stop and remain at least 50 feet from fouling the track on the conflicting route until the gate is changed to the stop position on the conflicting route. Where required, restore gate to its normal position after movement is complete.

### Obscured View of Conflicting Route

If a train must stop before entering a railroad crossing at grade and the view on the conflicting route is obscured, a crew member must go ahead of the train and signal from the crossing when it is safe to proceed.

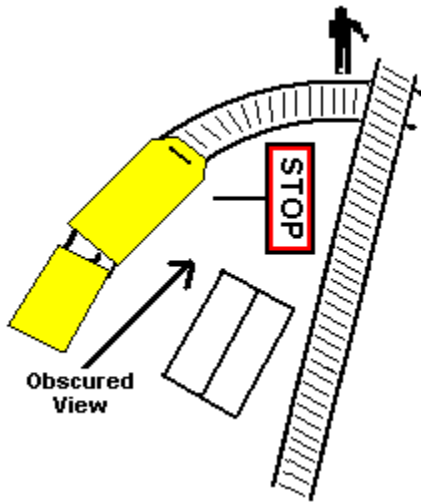

[Diagram B]

### Rule Updated Date

April 7, 2010

[^Top](#)

## 6.17: Switches at Junctions

The normal position for a junction switch is for through movement on the main track where the junction is an intermediate station.

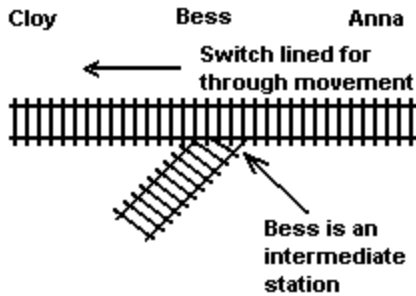

[Diagram A]

**Rule Updated Date**

April 7, 2010

[^Top](#)

**6.18: Stopping Clear of Crossings and Junctions**

At a railroad crossing or junction, a train or engine must not stop, if possible, where it could interfere with train movement on the other track.

**Rule Updated Date**

April 7, 2010

[^Top](#)

**6.19: Flag Protection**

**A. Flag Protection Not Required**

Flag protection is not required against following trains on the same track if:

1. Train is within ABS limits and the rear of the train is protected by at least two block signals or one block signal and one distant signal.
2. Rear of the train is within BRT, CTC, DTC, TWC or interlocking limits.
- or
3. General Order or special instructions specify that flag protection is not required.

**B. Flag Protection is Required**

When flag protection is required against following trains:

**1 More than Half the Maximum Timetable Speed**

- When a train is moving on a main track at or more than half the maximum authorized timetable speed for any train at that location, and the train may be overtaken by a following train, a flagman must decide whether to drop lighted fuses by considering the following:

- Grade of the track
- Curvature of the track
- Weather conditions
- Sight distance
- Speed of the train relative to a following train

## 2 Less than Half the Maximum Timetable Speed

When a train is moving on a main track at less than half the maximum authorized timetable speed for any train at that location, a flagman must provide flag protection against following trains on the same track. The flagman must drop off single lighted fuses at close enough intervals to ensure full protection and not exceed the burning time of the fusee.

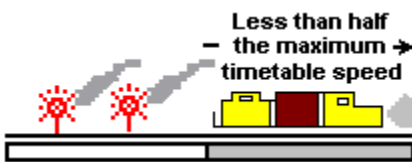

[Diagram A]^^

## 3 Stopped on a Main Track

When a train stops on a main track, a flagman must immediately go back at least 2 miles. Flagman must remain there until stopping a following train or until recalled.

If the flagman is recalled and safety will permit, the flagman must leave a lighted fusee and return to the train. If recalled before reaching the prescribed distance, the flagman must leave a lighted fusee. While returning to the train, the flagman must also place single lighted fusees at intervals shorter than the burning time of the fusee.

When the train departs, a crew member must leave one lighted fusee. In addition, until the train is moving at least half the maximum authorized timetable speed for any train at that location, a crew member must drop off single lighted fusees at intervals shorter than the burning time of the fusee.

### **Application:**

Flagging distance is 2 miles.

### **Rule Updated Date**

April 1, 2015

### **System Special Instructions**

Effective Date: April 1, 2015

[^Top](#)

## **6.20: Equipment Left on Main Track**

## **A. Portion of Train Left on Main Track**

When necessary to leave a portion of a train temporarily on the main track, follow this procedure:

- Set a sufficient number of hand brakes to keep the detached portion from moving.
- Provide protection against movements that may enter the main track between the detached portion and the returning front portion unless:
  - The train dispatcher verbally relieves the protection.
  - or
  - The return movement is otherwise authorized.
- Make return movement at restricted speed. However, an engine without cars may return at a higher speed when governed by block signal indication.

## **B. Other Equipment Left on Main Track**

Crews that leave equipment on the main track do not need to provide protection for the equipment if the train dispatcher gives verbal relief.

The train dispatcher may request a crew to report clear of their authority and leave equipment on a main track. Crews that leave equipment on a main track do not need to provide protection for the equipment if the train dispatcher provides relief. The train dispatcher must provide protection for the equipment.

All crews that use the main track at that point must be notified of the equipment location and must move at restricted speed when approaching that location.

### **Application:**

A train must not be left on the main track in non signaled territory unless protected by one of the following:

1. Yard Limits.
  2. Track Warrants.
- The train dispatcher may request the release of the crew's track warrant and inform crew that protection has been provided.
  - After being informed that protection has been provided, the following procedure must be followed:
    - Crew will state: "(Train ID) is stopped between MP\_\_\_ and MP\_\_\_ on main track (Subdivision). Protection has been provided."
    - Dispatcher will state: "( Train ID) that is correct."

A crew member will then release their track warrant.

### **Rule Updated Date**

May 5, 2021

### **System Special Instructions**

Effective Date: May 5, 2021

[^Top](#)

## 6.21: Precautions Against Unusual Conditions

Protect trains and engines against any known condition that may interfere with their safety.

When conditions restrict visibility, regulate speed to ensure that crew members can observe and comply with signal indications.

In unusually heavy rain, storm, or high water, trains and engines must approach bridges, culverts, and other potentially hazardous points prepared to stop. If movement cannot proceed safely, must stop until it is safe to resume movement.

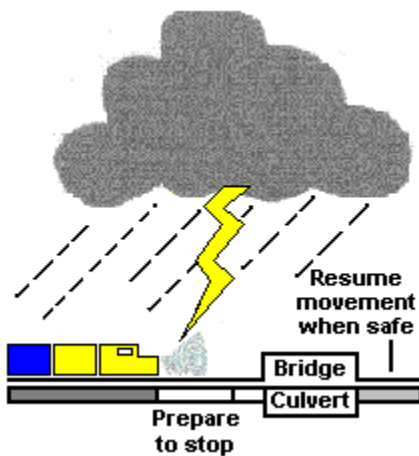

[Diagram A]^

Advise the train dispatcher of such conditions by the first available means of communication.

When notified Flash Flood (FF) warning in effect, comply with Procedure FF at or within the specified limit(s) as outlined below:

- Proceed prepared to stop short of washout or debris on track.
- Be governed by Rule 6.21 and Rule 6.21.2.

When notified High Wind (HW) warning in effect, unless otherwise authorized by the train dispatcher, comply with Procedure HW at or within the specified limit(s) as outlined below:

- All train movements approaching limits must stop before entering limits. (If closely approaching limits, stop consistent with proper train handling.)
- Freight trains within limits may operate not exceeding 10 MPH, prepared to stop short of obstructions or debris on track. (Immediately reduce speed, when necessary, consistent with proper train handling when notified.)
- Passenger trains within limits must stop.
- All train movements within limits must stop when actual or predicted sustained wind or gust speeds are 120 mph or greater.

Note: High Wind (HW) warnings will only be issued to affected trains based on blow-over limit.

**Rule Updated Date**

July 25, 2023

### **System Special Instructions**

Effective Date: July 11, 2023

### **General Order**

Effective Date: July 25, 2023

[^Top](#)

## **6.21.1: Protection Against Defects**

If any defect or condition that might cause an accident is discovered on tracks, bridges, or culverts, or if any crew member believes that the train or engine has passed over a dangerous defect, the crew member must immediately notify the train dispatcher and provide protection if necessary.

### **Rule Updated Date**

April 7, 2010

[^Top](#)

## **6.21.2: Water Above Rail**

Do not operate trains and engines over tracks submerged in water until the track has been inspected and verified as safe.

Operate engines at 5 MPH or less when water is above the top of the rail. If water is more than 3 inches above the top of the rail, a mechanical department supervisor must authorize the movement.

### **Rule Updated Date**

April 7, 2010

[^Top](#)

## **6.21.3: Track Obstruction/Unusual Conditions**

When a train is instructed by the Train Dispatcher in the words, "BETWEEN (location) AND (location) BE GOVERNED BY RULE 6.21.3", within specified limits, train must proceed at a speed which will permit stopping short of slide, rock, washout or debris on track.

### **Rule Updated Date**

April 1, 2015

### **System Special Instructions**



Effective Date: April 1, 2015

[^Top](#)

## **6.22: Maintaining Control of Train or Engine**

Crew members must consider train or engine speed, grade conditions, and air gauge indications to determine that the train or engine is being handled safely and is under control. If necessary, take immediate action to bring the train or engine under control.

### **Rule Updated Date**

April 7, 2010

[^Top](#)

## **6.23: Emergency Stop, Severe Slack Action, or Actuation of a Shifted Load or Dragging Equipment Detector**

When a train or engine is stopped by an emergency application of the brakes, severe slack action occurs while moving or stopping, or a train actuates a shifted load or dragging equipment detector take the following actions:

### **Obstruction of a Main Track(s) or Controlled Siding(s) - Application:**

If an adjacent main track(s) or controlled siding(s) may be obstructed, immediately:

- Warn other trains by radio by stating, "Emergency, Emergency, Emergency;" and give the exact location and status of the train and repeat as necessary.
- Place lighted fusees on adjacent track(s).
- Notify the train dispatcher or control operator and, when possible, foreign line railroads if necessary.
  - Ensure you are on the dispatcher's radio channel for the area you are in and dial DTMF digits "911" on the radio key pad.
  - If no acknowledgment of emergency call-in is received, resend the "911" code.

Warning to other movements is no longer necessary when:

- It is known adjacent track(s) are not obstructed.  
or
- The train dispatcher or control operator advises the crew that protection is provided on adjacent track(s).

### **Train on Adjacent Track**

A train on an adjacent track that receives radio notification must pass the location specified at restricted speed and stop short of any portion of the stopped train fouling their track. When advised that the track is clear and it is safe to proceed, this restriction no longer applies.

### **Inspection of Cars and Units:**

Visual inspection of the train must be made on each side of all cars, units, equipment, and track to ensure they are in a safe

condition. Make sure the marker is attached to the designated rear car. Before proceeding, check the proper positioning of all wheels on the rail.

### **A. Emergency Application of the Brakes When Initiating Movement**

When initiating movement of a train that has been stopped and an emergency brake application occurs, if a train separation is discovered during the inspection, further visual inspection is not required when device located at rear of train indicates brake pipe pressure is being restored after re-coupling train.

### **B. Emergency Application of the Brakes / Severe Slack Action When Moving or Stopping**

1. An inspection of the entire train must be made while stopped if:

- Train is a Key Train.
- or
- Severe slack action or train separation occurred.

If physical characteristics prevent a complete visual inspection while stopped, inspect as much of the train as possible. The train may then be moved, but may not exceed 5 MPH for the distance necessary to complete the inspection, and must be stopped immediately if excessive power is required to start or keep the train moving.

2. When all of the following conditions are met, train may be moved not exceeding 5 MPH under direct observation of crew member or other qualified employee to assist with inspection. Train must be stopped immediately if excessive power is required to start or keep the train moving during inspection.

- Train is not a Key train.
- No severe slack action or train separation occurred.
- Device located at rear of train immediately indicates that brake pipe pressure is being restored.
- Train is not operating on rails with concrete ties.
- It has been verified adjacent track(s) are not occupied and no other movement on adjacent track(s) will be made until inspection has been completed.

3. Trains, other than Key Trains, that did not experience severe slack action or train separation, are relieved of visual inspection required by an emergency application when any of the following conditions are met and device located at rear of train immediately indicates brake pipe pressure is being restored. \*\*

- Train is a solid loaded bulk commodity train.
- Train is made up entirely of well cars and/or five-platform articulated single-level spine cars.
- Train speed is above 20 MPH.
- or
- Train is 5000 tons or less.

Stop immediately and inspect train if excessive power is required to start or keep the train moving.

\*\* When a train line defect is corrected during the inspection, such as re-coupling an air hose, closing a stuck vent valve, etc., and device located at rear of train immediately indicates brake pipe pressure is being restored:

- If operating on rails with concrete ties, train may be moved to complete the inspection not exceeding 5 MPH.

- If operating on rails with wooden ties, no further inspection is required.

### **C. Shifted Load or Dragging Equipment Detector Actuation**

After complying with instructions for Obstruction of Main Track(s) or Controlled Siding(s), the following applies:

- When emergency application of the brakes or severe slack action occurs, train must be inspected while stopped.
- If no emergency application of the brakes or severe slack action occurs, inspect as required in System Special Instructions, Item 13.

#### **Rule Updated Date**

May 10, 2022

#### **System Special Instructions**

Effective Date: May 10, 2022

[^Top](#)

## **6.24: Movement on Double Track**

On double track, trains must keep to the right unless otherwise instructed.

#### **Rule Updated Date**

April 7, 2010

[^Top](#)

## **6.25: Movement Against the Current of Traffic**

Movements against the current of traffic must be authorized by track bulletin or track warrant, except as provided by:

- Rule 6.13 (Yard Limits)
  - Rule 6.14 (Restricted Limits)
  - Rule 9.15 (Track Permits)
  - Rule 9.17.1 (Signal Protection in ABS by Lining Switch).
- OR
- Rule 16.1 (Authority to Enter DTC Limits)

Movements must approach block and interlocking signals prepared to stop unless signals indicate proceed.

When a facing point movement will be made over a spring switch, comply with Rule 8.9.1 (Testing Spring Switch).

#### **Rule Updated Date**

April 7, 2010

[^Top](#)

## 6.26: Use of Multiple Main Tracks

Multiple main tracks will be designated by name or number. When necessary, track use will be indicated in the special instructions.

### Application:

Multiple main tracks are numbered as follows:

- On east-west subdivisions, track numbers increase from north to south, and the northern most track is No. 1.
- On north-south subdivisions, track numbers increase from west to east, and the western most track is No. 1.

### Rule Updated Date

April 1, 2015

### System Special Instructions

Effective Date: April 1, 2015

[^Top](#)

## 6.27: Movement at Restricted Speed

When required to move at restricted speed, movement must be made at a speed that allows stopping within half the range of vision short of:

- Train.
- Engine.
- Railroad car.
- Men or equipment fouling the track.
- Stop signal.
- or
- Derail or switch lined improperly.

When a train or engine is required to move at restricted speed, the crew must keep a lookout for broken rail and not exceed 20 MPH.

Comply with these requirements until the leading wheels reach a point where movement at restricted speed is no longer required.

### Application:

Train and / or engine speed must allow for movement to stop short of the obstructions listed consistent with good train

handling.

**Rule Updated Date**

April 1, 2015

**System Special Instructions**

Effective Date: April 1, 2015

[^Top](#)

## **6.28: Movement on Other than Main Track**

Except when moving on a main track or on a track where a block system is in effect, trains or engines must move at a speed that allows them to stop within half the range of vision short of:

- Train.
- Engine.
- Railroad car.
- Men or equipment fouling the track.
- Stop signal.
- or
- Derail or switch lined improperly.

**Application:**

Train and/or engine speed must allow for movement to stop short of the obstructions listed consistent with good train handling.

**Rule Updated Date**

April 1, 2015

**System Special Instructions**

Effective Date: April 1, 2015

[^Top](#)

### **6.28.1: Sidings of Assigned Direction**

Do not use sidings of an assigned direction in the opposite direction unless authorized by the train dispatcher.

**Rule Updated Date**

April 7, 2010

[^Top](#)

## **6.28.2: Stopping Clear in Siding**

When possible, a train entering a siding must not stop until the entire train is clear of the main track.

### **Rule Updated Date**

April 7, 2010

[^Top](#)

## **6.28.3: Cars or Equipment Left on Siding**

Avoid leaving cars or equipment on sidings unless authorized by the train dispatcher, except in an emergency. In this case, notify the train dispatcher immediately.

### **Rule Updated Date**

April 7, 2010

[^Top](#)

## **6.29: Inspecting Trains**

### **Rule Updated Date**

April 7, 2010

[^Top](#)

### **6.29.1: Inspecting Passing Trains**

Employees must inspect passing trains. If they detect any of the following conditions, they must notify crew members on the passing train by any available means:

- Overheated journals
- Sticking brakes
- Sliding wheels
- Wheels not properly positioned on the rail
- Dragging equipment
- Insecure contents
- Signs of smoke or fire
- Headlight or marker improperly displayed
- Any other dangerous condition

When possible, employees inspecting the passing train must advise crew members of the condition of their train.

When possible, a crew member on the engine of the train being inspected must notify a crew member on the rear of the train when the train is being inspected by other employees.

## **Ground Inspections**

When a train is stopped and is met or passed by another train, crew members must inspect the passing train. The inspection will be made from the ground if there is a safe location. If safe to do so, a crew member other than the engineer must cross the track and inspect the side of the passing train opposite the stopped train. When stopped, the crew member must detrain on the field side, the side away from the adjacent main track.

Inspection will be made from the cab of the locomotive:

- During snow and ice conditions that may cause slippery conditions underfoot when getting on or off.  
or
- When stopped at a location where it is unsafe to detrain or there is an adjacent main track on each side of the train (i.e. on track 2 in 3 main track territory).

## **Trackside Warning Detectors and Inspections**

Crew members must be aware of trackside warning detectors and signals from persons inspecting their train. Stop the train immediately for an inspection when any of the following conditions exist:

- A crew member receives a stop signal.
- A trackside warning detector indicates a train defect.  
or
- A crew member is notified of a dangerous condition.

Movement must not proceed until it is safe.

### **Application:**

When a trackside warning detector indicates a train defect, stop train according to instructions contained in Item 13.

### **Rule Updated Date**

May 10, 2022

### **System Special Instructions**

Effective Date: May 10, 2022

[^Top](#)

## **6.29.2: Train Inspections by Crew Members**

When a walking inspection of the train is required, and physical characteristics prevent a complete train inspection, inspect as much of the train as possible. The train may then be moved, but may not exceed 10 MPH for the distance necessary to complete the inspection.

While their train is moving, crew members must inspect it frequently and look for indications of defects in the train, especially when rounding curves.

When inspecting their train, crew members must observe the train closely for any of the following:

- Overheated journals
- Sticking brakes
- Sliding wheels
- Wheels not properly positioned on the rail
- Dragging equipment
- Insecure contents
- Signs of smoke or fire
- Any other dangerous condition

Crew members who discover defects while the train is moving must stop the train promptly and correct any defects, if possible. If the defective car must be set out, they must not attempt to move the car to the setout point unless it is safe to do so.

When a car is set out because of an overheated journal, any fire must be completely extinguished and precautions taken to prevent further ignition.

#### **Rule Updated Date**

December 29, 2017

#### **System Special Instructions**

Effective Date: June 1, 2018

[^Top](#)

## **6.30: Receiving or Discharging Passengers**

### **A. Passenger Crew Responsibilities**

When approaching a station to receive or discharge passengers, determine if the train is routed on the track nearest the station platform. If other trains could pass on a main track or controlled siding between the passenger train and the station platform:

- Communicate with the train dispatcher to determine whether any trains are approaching between the train and the station platform.
- Do not make the station stop until assured that trains will not pass between the train and the station platform.

If unable to communicate with the train dispatcher, the station stop may be made after the crew determines that no trains are approaching on the track between the train and the station platform. Before making the station stop, the conductor must assign crewmember responsibilities to ensure passenger safety. If during the station stop a train is seen or heard approaching, crewmembers must take immediate action to keep passengers from fouling the affected track.

### **B. Responsibilities of Approaching Movements**



When notified that a passenger train will be at a station, do not pass between station platform and a passenger train until assured that all passengers and employees have cleared the track between the passenger train and the station platform. Movement may then pass when preceded by an employee walking ahead of the movement.

### **C. Other than Main Track Movements**

A movement must not pass between a passenger train and the station platform being used unless safeguards are provided.

#### **Rule Updated Date**

April 7, 2010

[^Top](#)

## **6.31: Maximum Authorized Speed**

All crew members are responsible for knowing and not exceeding the maximum authorized speed for their train. Passenger speed is applicable only to trains consisting entirely of passenger equipment.

When possible, a crew member must promptly notify the train dispatcher of any condition that will delay or prevent the train from making usual speed.

#### **Rule Updated Date**

May 1, 2014

[^Top](#)

### **6.31.1: Permanent Speed Restrictions**

Permanent speed restrictions must not be exceeded until the rear of the train clears the limits of the restriction, unless otherwise specified.

#### **Rule Updated Date**

April 7, 2010

[^Top](#)

## **6.32: Crossings**

#### **Rule Updated Date**

May 10, 2022

#### **System Special Instructions**

Effective Date: May 10, 2022

[^Top](#)

## 6.32.1: Providing Warning Over Crossings

An employee must be on the ground at the crossing to provide warning until crossing is occupied when shoving equipment (including non-controlling locomotives), kicking cars, or performing a gravity switch move over highway/pathway - rail grade crossings. Movement must only be made as directed by the employee providing warning at the crossing.

Within a yard, this only applies to crossings open to:

- Unrestricted public access.  
or
- Persons other than railroad employees performing normal duties.

Warning is not required when crossing is equipped with:

- Gates that are in the fully lowered position.  
or
- Flashing lights or passive warning devices (cross-bucks, stop signs, etc.) when it is clearly seen that no traffic is approaching or stopped at the crossing. Leading end of shoving movement must not exceed 15 MPH over crossings. Application: Stop movement before fouling crossing(s), and provide warning when visibility is limited due to riding location on equipment, weather or lighting conditions, vegetation, structures, etc.

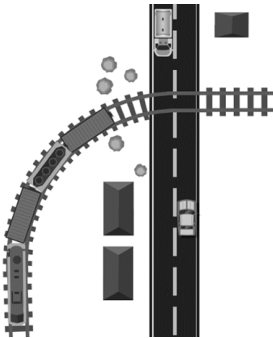

### Rule Updated Date

April 30, 2024

### System Special Instructions

Effective Date: May 10, 2022

### General Order

Effective Date: April 30, 2024

[^Top](#)

## 6.32.2: Crossing Warning Devices (Highway/Pathway - Rail Grade Crossings)

Under any of the following conditions, a movement must not foul a crossing equipped with automatic warning devices until the device has been operating long enough to provide warning and the crossing gates, if equipped, are fully lowered:

- Train, engine, and other such movements consisting of 12 physical axles or less. However, Self Propelled Engineering Department Track Geometry cars will be governed by Engineering Department instructions.
  - Movement has stopped within 3,000 feet of the crossing.
  - Movement is within 3,000 feet of the crossing and speed has increased by more than 5 MPH.
  - Movement is closely following another movement.
  - Movement is on other than the main track or siding.
- or
- Movement enters a main track or siding within 3,000 feet of the crossing.

**Employees must observe crossing warning devices and report any that are malfunctioning, damaged, or missing by the first available means of communication to the:**

- **Train dispatcher**
- or
- **Grade Crossing Safety Hot Line (800-848-8715).**

**Notify all affected trains as soon as possible.**

**If equipped, when the white power-on light on the exterior of the signal house is not lit or when a strobe light on the exterior of the signal house is flashing, immediately notify the train dispatcher or Grade Crossing Safety Hot Line.**

### **Notification:**

When a crew receives notification that a crossing warning device may be disabled, malfunctioning, damaged, or missing, sound whistle signal 5.8.2(7) regardless of any prohibition and comply with the appropriate procedure.

### **Procedure XC or XI:**

The train may proceed over the crossing not exceeding 15 MPH.

### **Procedure XH:**

Unless otherwise instructed by signal employee in charge, train must approach crossing prepared to stop before entering crossing and if automatic warning devices are:

- Seen to be working\* or when instructed by the train dispatcher or proper authority, proceed over the crossing not exceeding 15 MPH without stopping.
- \* Crossing with broken gate(s) is considered as having working devices when the balance of the automatic warning devices are seen to be working.
- or

- Not working, comply with Procedure XG.

**Procedure XG:**

Unless otherwise instructed by signal employee in charge, train must stop before fouling crossing regardless of the condition of automatic warning devices. A crew member must be on the ground at the crossing to warn highway traffic. The train may proceed over the crossing as directed by that crew member.

**Stopping is not required for Procedure XG or XH when the crew communicates with a flagger before fouling the crossing and receives confirmation that warning is being provided by:**

- One equipped flagger who can provide warning for one direction of approaching traffic. Proceed over the crossing not exceeding 15 MPH without stopping until the head end of the train completely occupies the crossing.  
or
- Two or more equipped flaggers who can provide warning in all directions of approaching traffic. Proceed over the crossing at maximum authorized speed.

**Flagger:**

A flagger is a person other than a crew member who is equipped with a vest, shirt, or jacket of a high visibility color appropriate for daytime flagging such as orange, yellow, strong yellow green or fluorescent versions of these colors. At night, similar outside garments must be retro reflective. The flagger must have a red flag by day and a light at night.

**"STOP" Sign and Crossing Warning Device Malfunction Sign:**

Where a STOP sign or Crossing Warning Device Malfunction Sign (SSI Item 22) is located next to a road crossing, movement must stop at the STOP sign. Movement may proceed only after automatic crossing warning devices have been operating long enough to provide warning and crossing gates, if equipped, are fully lowered. If automatic crossing warning devices fail to operate, a crew member must be on the ground at the crossing to warn highway traffic. The train may proceed over the crossing as directed by that crew member.

**Resuming Maximum Speed:**

When leading end of movement completely occupies the crossing, proceed at maximum authorized speed.

XC – Cars have been left closer than the required distance from the crossing.

XI – Due to broken crossbuck, stop sign, vegetation, etc.

XH – Automatic Crossing Warning Device False or Partial Activation.

XG – Automatic Crossing Warning Device Activation Failure or Disabled

**Rule Updated Date**

June 1, 2022

**System Special Instructions**

Effective Date: July 11, 2023

[^Top](#)

### 6.32.3: Providing Warning for Adjacent Tracks

When practical, position an employee on the ground to warn traffic against movements approaching on adjacent tracks, under either of the following conditions:

- A train or cut of cars is parted closer than 250 feet from a road crossing.
- The head-end of a train is stopped, other than a passenger station stop, closer than 250 feet from a road crossing.

#### Rule Updated Date

May 10, 2011

[^Top](#)

### 6.32.4: Clear of Crossings and Signal Circuits

Leave cars, engines, or equipment clear of road crossings and crossing signal circuits.

When practical, avoid leaving cars, engines, or equipment standing closer than 250 feet from the road crossing when there is an adjacent track.

When cars, engines, or equipment are left on a siding or a main track closer than the required distance, the train dispatcher must be notified.

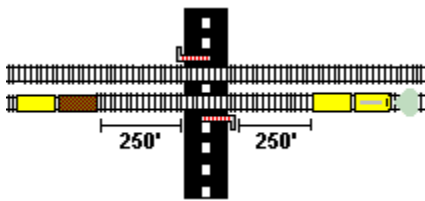

[Diagram A]^

#### Application:

Referring to 250 feet:

- In Illinois, the distance is 500 feet.
- In Wisconsin, the distance is 330 feet.
- In Arkansas and Louisiana the distance is 300 feet.

#### Rule Updated Date

April 1, 2015

#### System Special Instructions

Effective Date: April 1, 2015

[^Top](#)

### **6.32.5: Actuating Automatic Warning Devices Unnecessarily**

Avoid actuating automatic warning devices unnecessarily by leaving switches open or permitting equipment to stand within the controlling circuit. If this cannot be avoided and if the signals are equipped for manual operation, a crew member must manually operate the signal for movement of traffic. A crew member must restore signals to automatic operation before a train or engine occupies the crossing or before it leaves the crossing.

#### **Rule Updated Date**

April 7, 2010

[^Top](#)

### **6.32.6: Blocking Public Crossings**

When practical, a standing train or switching movement must avoid blocking a public crossing longer than 10 minutes.

#### **Rule Updated Date**

April 7, 2010

[^Top](#)

### **6.32.7: Road Crossings within Intermodal and Automotive Facilities**

Movements over crossings within intermodal and vehicle loading/unloading facilities will be made as follows:

- Shoving movements and locomotive consist movements, when not controlled from the cab nearest the direction of travel, must be protected by an employee on the ground at the crossing to warn traffic until the crossing is occupied. Make movement over the crossing only after warning has been provided. Note: Warning is not required when it is clearly seen that no traffic is approaching or stopped at the crossing.
- Movements with the engine in the lead, when controlled from the cab nearest the direction of travel, must ring the engine bell when approaching crossing. In addition, sound whistle as a warning when vehicles are stopped, closely approaching or crossing view is obstructed.

#### **Rule Updated Date**

July 11, 2023

#### **System Special Instructions**

Effective Date: July 11, 2023

[^Top](#)

## [Union Pacific Rules](#)

### UPRR - General Code of Operating Rules

## **7.0: SWITCHING**

- [7.1: Switching Safely and Efficiently](#)
- [7.2: Communication Between Crews Switching](#)
- [7.3: Additional Switching Precautions](#)
- [7.4: Precautions for Coupling or Moving Cars or Engines](#)
- [7.4.1: Remote Control Couplings](#)
- [7.5: Testing Hand Brakes](#)
- [7.6: Securing Cars or Engines](#)
- [7.7: Kicking or Dropping Cars](#)
- [7.7.1: Gravity Switch Moves](#)
- [7.8: Coupling or Moving Cars on Tracks Where Cars are Being Loaded or Unloaded](#)
- [7.9: Switching Passenger or Occupied Outfit Cars](#)
- [7.10: Movement Through Gates or Doorways](#)
- [7.11: Charging Necessary Air Brakes](#)
- [7.12: Movements Into Spur Tracks](#)
- [7.13: Protection of Employees in Bowl Tracks](#)

### **7.1: Switching Safely and Efficiently**

While switching, employees must work safely and efficiently and avoid damage to contents of cars, equipment, structures, or other property.

Do not leave equipment standing where it will foul equipment on adjacent tracks or cause injury to employees riding on the side of a car or engine.

On tracks where clearance point is indicated, leave equipment beyond the clearance point.

If clearance point is not indicated or visible, determine the clearance point by standing outside the rail of adjacent track and extend arm towards the equipment. When unable to touch the equipment, leave equipment at least an additional 50 feet into the track to ensure equipment is beyond the clearance point.

Equipment may be left on a:

- Main track, fouling a siding track switch, when the switch is lined for the main track.
  - Siding, fouling a main track switch, when the switch is lined for the siding.
  - Yard switching lead, fouling a yard track switch when the switch is lined for the yard switching lead.
- or
- Industry track beyond the clearance point of the switch leading to the industry.

**Rule Updated Date**

April 7, 2010

[^Top](#)

**7.2: Communication Between Crews Switching**

To avoid injury or damage where engines may be working at both ends of a track or tracks, crews switching must have a clear understanding of movements to be made.

**Rule Updated Date**

April 7, 2010

[^Top](#)

**7.3: Additional Switching Precautions**

The following equipment must not be unnecessarily switched or couplings made so as to damage the equipment or load:

- Passenger or outfit cars.
- Intermodal or TOFC cars.
- Cabooses.
- Loaded Autoracks.
- Cars containing livestock.
- Open top loads subject to shifting.

The following equipment must not be cut off in motion or struck by any car moving under its own momentum:

- Passenger cars.
- Outfit cars.
- High-value loads.
- Engines.
- Loaded-depressed-center flat cars.
- Cars loaded with modular housing units.
- Articulated and solid drawbar-connected cars with more than two car bodies. However, when empty, these cars may be kicked but not humped.
- Scale test cars.
- Roadway equipment.

**Rule Updated Date**

May 20, 2019

**System Special Instructions**



Effective Date: May 20, 2019

[^Top](#)

## **7.4: Precautions for Coupling or Moving Cars or Engines**

Before coupling to or moving cars or engines, verify that the cars or engines are properly secured and can be coupled and moved safely.

Make couplings at a speed of not more than 4 MPH. Ensure coupling(s) are made, using engine to stretch slack if necessary. Before beginning shoving movement, ensure that all couplings have been stretched.

### **Rule Updated Date**

May 5, 2021

### **System Special Instructions**

Effective Date: May 5, 2021

[^Top](#)

### **7.4.1: Remote Control Couplings**

When using a remote control locomotive in "pitch and catch" operations to make a coupling, the RCO located at the coupling must be the primary operator. This does not prevent a utility employee, not equipped as a RCO, from making the coupling.

Make couplings at a speed of not more than 2 MPH. Remote Control Operator must use speed selection of not greater than "Couple".

Do not use "Coast" and independent brake override to make car couplings.

**Note:** When spotting cars at an industry that requires precision spotting of the cars the independent brake override may be used.

### **Rule Updated Date**

April 1, 2015

### **System Special Instructions**

Effective Date: April 1, 2015

[^Top](#)

## **7.5: Testing Hand Brakes**

Employees must know how to operate the type of brakes they are using. When hand brakes must control or prevent movement, test the brakes to ensure that they are operating properly before using them. If hand brake is not operational, attach a bad order tag to hand brake wheel or lever.

**Rule Updated Date**

May 10, 2022

**System Special Instructions**

Effective Date: May 10, 2022

[^Top](#)

## **7.6: Securing Cars or Engines**

Do not depend on air brakes to hold a train, engine, or cars in place when left unattended. Apply a sufficient number of hand brakes to prevent movement. If hand brakes are not adequate, block the wheels.

When the engine is coupled to a train or cars standing on a grade, do not release the hand brakes until the air brake system is fully charged.

When cars are moved from any track, apply enough hand brakes to prevent any remaining cars from moving.

**Rule Updated Date**

April 7, 2010

[^Top](#)

## **7.7: Kicking or Dropping Cars**

Kicking or allowing cars to roll under their own momentum is only permitted at authorized locations and when it will not endanger employees, equipment, or contents of cars. This does not apply to crews actively humping cars.

When kicking cars, crew member must ensure that cars kicked are clear of and will remain clear of next track to be entered before track is fouled.

Dropping cars is prohibited.

**Rule Updated Date**

April 1, 2015

**System Special Instructions**

Effective Date: April 1, 2015

[^Top](#)

## **7.7.1: Gravity Switch Moves**

Unless otherwise restricted, a gravity switch move may be utilized where cars must be repositioned on the opposite end of the engine. Not more than five cars may be handled at one time.

When making a gravity switch move:

- Hand brakes must be tested to ensure proper operation.
- Sufficient hand brakes must be manned by crew members to ensure that the movement can be controlled and stopped.
- Using the hand brake on cars with shiftable loads must be avoided when practicable.
- Cars must not be allowed to couple to other equipment.

A gravity switch may only be made where authorized by "Superintendent Bulletin" and manned hand brake must be located on the trailing end of the trailing car in the direction of movement.

### **Rule Updated Date**

April 1, 2015

### **System Special Instructions**

Effective Date: April 1, 2015

[^Top](#)

## **7.8: Coupling or Moving Cars on Tracks Where Cars are Being Loaded or Unloaded**

Before coupling to or moving cars on tracks where cars are being loaded or unloaded, crew members must be sure that all of the following have been removed or cleared:

- Persons in, on, or about cars
- Platforms
- Boards
- Tank car couplings and connections
- Conveyors
- Loading or unloading spouts and similar appliances or connections
- Vehicles
- Other obstructions

In addition:

- Be careful to avoid damage to freight of partly loaded cars.
- Do not handle cars that are improperly or unevenly loaded if load could shift or fall from the car, or if the car could derail or overturn.
- Return any car placed for loading or unloading to the location it was found if it has not been released for movement.

- Do not pull empty cars from an unloading facility until cables, straps, and other devices used to secure lading are secured and any major accumulation of debris is removed by the customer.
- Ensure that plug-type and swinging doors on cars are closed or secured. However, crew members must not attempt to close those doors. If plug door is found open enroute, car may continue in the train to the next location where mechanical forces are available to close door.

**Rule Updated Date**

April 1, 2015

**System Special Instructions**

Effective Date: April 1, 2015

[^Top](#)

## **7.9: Switching Passenger or Occupied Outfit Cars**

Before switching passenger equipment or occupied outfit cars:

- Couple the air hoses.
- Fully charge the brake system.
- Use the automatic brake valve when switching.

When coupling passenger or outfit cars:

- Stop the movement approximately 50 feet before the coupling is made.
- Have an employee on the ground direct the coupling.
- Ensure couplers are fully compressed and stretched to ensure that knuckles are locked before making:
  - Air connections
  - Steam connections
  - Electrical connections

**Rule Updated Date**

April 7, 2010

[^Top](#)

## **7.10: Movement Through Gates or Doorways**

Before moving engines, cars, or other equipment through gates, doorways, or similar openings, stop to ensure that the gates, doorways, or openings are completely open and secure. When overhead or side clearances are close, make sure movement is safe. Do not ride on the side of a car, engine, or other equipment when moving through gates, doorways, or similar openings.

**Rule Updated Date**

April 1, 2015

[^Top](#)

## 7.11: Charging Necessary Air Brakes

Do not handle cars without charging the air brake system, unless the cars can be handled safely and stopped within the required distance. If necessary, couple the air hoses and charge the brake systems on a sufficient number of cars to control movement.

### Rule Updated Date

April 7, 2010

[^Top](#)

## 7.12: Movements Into Spur Tracks

When shoving equipment into a spur track, control movement to prevent damage at the end of the track, and do the following:

- Stop movement 150 feet from the end of the track.
- Apply hand brakes, when necessary, to control slack when shoving cars.
- Have a crew member precede any further movement when it can be done safely.
- Move only on the crew member's signal.
- Stop movement short of end of track, bumper, chock, etc., unless it is necessary to shove equipment to the end of the track to properly spot equipment.
- When necessary, use extreme caution to avoid damage to equipment, track or structures.

### Rule Updated Date

April 19, 2022

### System Special Instructions

Effective Date: May 10, 2022

[^Top](#)

## 7.13: Protection of Employees in Bowl Tracks

During humping operations, before a train or yard crew member performs any work activities between bowl tracks, protection must be provided against cars released from the hump into the bowl track **that will be fouled** as follows:

- The employee requesting protection must notify the employee controlling the switches that provide access from the hump to the bowl track where work will occur.
- After being notified, the switch controller must line any remote control switch against movement to the affected bowl track and locking or blocking device must be applied to the switch control.

- The switch controller must then notify the employee that protection is provided. Protection will be maintained until the switch controller is advised that work is complete and employee is clear of the bowl track and protection is no longer required.

**Rule Updated Date**

May 2, 2016

**System Special Instructions**

Effective Date: May 2, 2016

[^Top](#)

## [Union Pacific Rules](#)

UPRR - General Code of Operating Rules

### **8.0: SWITCHES**

- [8.1: Hand Operation of Switches](#)
- [8.2: Position of Switches](#)
- [8.3: Main Track Switches](#)
- [8.4: Lining Main Track Switch](#)
- [8.5: Not Used](#)
- [8.6: Restoring Switch to Normal Position](#)
- [8.7: Clear of Main Track Switches](#)
- [8.8: Switches Equipped with Locks, Hooks, or Latches](#)
- [8.9: Movement Over Spring Switches](#)
  - [8.9.1: Testing Spring Switch](#)
  - [8.9.2: Trailing Through and Stopping on a Spring Switch](#)
  - [8.9.3: Hand Operating a Spring Switch Before Making a Trailing Movement](#)
  - [8.9.4: During Snow or Ice Storms](#)
  - [8.9.5: Spiking Spring Switch](#)
  - [8.9.6: Approaching a Spring Switch in Non-Signaled Territory](#)
- [8.10: Switch Point Indicator](#)
- [8.11: Switches in Sidings](#)
- [8.12: Hand-Operated Crossover Switches](#)
- [8.13: Scale Track Switches](#)
- [8.14: Conflicting Movements Approaching Switch](#)
- [8.15: Switches Run Through](#)
- [8.16: Damaged or Defective Switches](#)
- [8.17: Avoid Sanding over Movable Parts](#)
- [8.18: Variable Switches](#)
- [8.19: Automatic Switches](#)
  - [8.19.1: Radio Controlled Switches](#)
- [8.20: Derail Location and Position](#)

#### **8.1: Hand Operation of Switches**

Spring or dual control switches operated by hand are considered hand-operated switches, and all rules governing hand-operated switches apply.

**Rule Updated Date**

April 7, 2010

[^Top](#)

## 8.2: Position of Switches

The employee operating the switch or derail is responsible for the position of the switch or derail in use. Movement must not foul an adjacent track until the hand-operated switch is properly lined.

Do not operate a switch that is tagged. If the switch is spiked, do not remove the spike unless authorized by the same craft or group that placed it.

Employees operating switches and derails must make sure:

- The switches and derails are properly lined for the intended route.
- The points fit properly and the target, if so equipped, corresponds with the switch's position.
- When the operating lever is equipped with a latch, they do not step on the latch to release the lever except when operating the switch.
- The switch is not operated while equipment is fouling, standing on, or moving over the switch.
- When equipment has entered a track, the switch to that track is not lined away until the equipment has passed the clearance point of the track.

When possible, crew members on the engine must see that the switches and derails near the engine are properly lined.

### Rule Updated Date

January 1, 2024

### System Special Instructions

Effective Date: July 11, 2023

### General Order

Effective Date: January 1, 2024

[^Top](#)

## 8.3: Main Track Switches

The normal position of a main track switch is for main track movement, and it must be lined and locked in that position. At points where double track begins, the normal position of a spring switch is for movement with the current of traffic.

However, the main track switch may be left open:

- In CTC territory within track and time limits.
- When attended by a crew member or switch tender.
- During switching operations when it is certain that no other train or engine will pass over the switch.



- For another train or engine when the switch is attended by a member of that crew.
- Within ABS limits when instructed by the train dispatcher at:
  - The entering switch of a siding in Rule 9.14 (Movement with the Current of Traffic) territory.
  - Either switch of a siding in Rule 16.1 (Authority to Enter DTC Limits) territory.
- Within TWC territory when authorized by track warrant. Track warrant protection must be provided for this condition. The switch must not be considered restored to normal position until the train dispatcher is notified by an employee at that location.  
or
- Within ABS-TWC, ABS-DTC, or Rule 9.14 (Movement with the Current of Traffic) territory at the entering switch of a siding after the following has been done:
  1. Communication has been established between crews of trains meeting or passing.
  2. An understanding has been reached that the train on the main track will stop and restore the switch to the normal position. A crew member must not report clear of the limits until it is known the switch is lined and locked in the normal position.

On main track switches (if equipped), the target will be red if the switch is lined in other than its normal position.

Before leaving the location where a hand-operated main track switch was operated:

- Crew members must confirm the position of the switch with each other.
- Engineering Department employees granted authority to enter working limits must confirm the position of the switch with the employee in charge or a designated employee who will notify the employee in charge.

**Rule Updated Date**

April 7, 2010

[^Top](#)

## **8.4: Lining Main Track Switch**

When an employee lines the switch to let a train enter or leave the main track, the employee must then go to the opposite side of the main track and not return to the switch stand until movement is complete. If unable to go to the opposite side of the track, the employee must stand at least 20 feet from the switch stand.

**Rule Updated Date**

April 7, 2010

[^Top](#)

## **8.5: Not Used**

**Rule Updated Date**

May 29, 2015

[^Top](#)

## 8.6: Restoring Switch to Normal Position

An employee getting off moving equipment to return the main track switch to normal position must, when possible, get off the equipment on the opposite side from the switch stand.

### Rule Updated Date

April 7, 2010

[^Top](#)

## 8.7: Clear of Main Track Switches

Except in switching movements, when a train or engine is approaching or passing on a main track, employees must not go nearer than 20 feet to any main track switch.

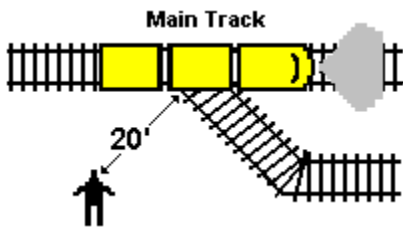

[Diagram A]

When a train or engine that will be met or passed is on a siding or other track, the employee attending the switch must be in a safe location. The employee must not be nearer than 150 feet, if possible, from the switch when the train is closely approaching and passing.

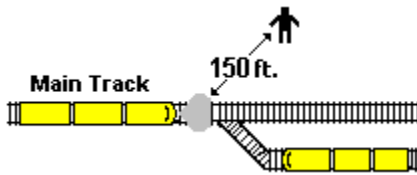

[Diagram B]

## Inspecting Hand-Operated Switches in Non-Signaled Territory

In non-signaled territory, if the expected train is not closely approaching, a crew member will inspect facing point, hand-operated switches the train will pass over to determine that the:

- Switches are lined for the intended route.
- Switch points fit properly.
- Switch lever is secured.

### Rule Updated Date

April 7, 2010

[^Top](#)

## **8.8: Switches Equipped with Locks, Hooks, or Latches**

When not in use, switches must be locked, hooked, or latched if so equipped. After locking a switch or derail, test the lock to ensure it is secured. Before making movements in either direction over these switches, make sure the switch is latched or secured by placing the lock or hook in the hasp. However, when making train movements in facing point direction, lock the switches equipped with a lock.

Replace any missing or defective switch locks. If they cannot be replaced, report the condition at once to the train dispatcher, yardmaster, or supervisor in charge, and spike the switch if possible.

### **Rule Updated Date**

January 1, 2024

### **General Order**

Effective Date: January 1, 2024

[^Top](#)

## **8.9: Movement Over Spring Switches**

Spring switches are identified by the letters S or SS, special targets, signs, and/or lights.

### **Rule Updated Date**

April 7, 2010

[^Top](#)

### **8.9.1: Testing Spring Switch**

A crew member tests the switch by lining the switch over and back by hand and examining the switch points to see that they fit properly.

Before a train or engine makes a facing point movement over a spring switch, the switch must be tested when any of the following conditions exist:

1. A block signal governing movement over the switch indicates:
  - Stop.
  - Stop and Proceed.
  - or
  - Restricted Proceed.

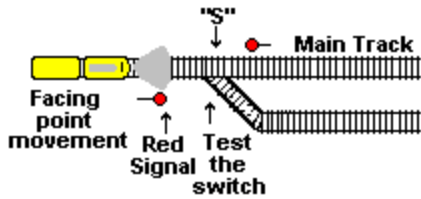

[Diagram A]

2 A switch point indicator protecting the switch indicates Stop and Inspect Switch.

. or

3 The switch is not protected by a block signal or switch point indicator.

The switch does not need to be tested if it has been lined for the diverging route or written instructions advise the crew that the spring switch has been spiked.

### Rule Updated Date

April 7, 2010

[^Top](#)

## 8.9.2: Trailing Through and Stopping on a Spring Switch

A train or engine trailing through and stopping on a spring switch must control the slack. A crew member must line the switch by hand before the train or engine can change direction or take slack.

Do not manually operate a spring switch when springs are compressed by wheels, except in an emergency. In an emergency, keep clear of the handle when it is released.

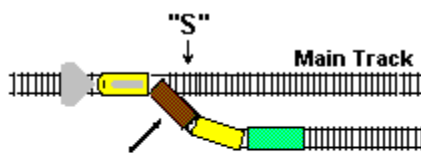

Line the switch  
before changing  
direction or  
taking slack

[Diagram A]

### Rule Updated Date

January 7, 2019

### System Special Instructions

Effective Date: May 10, 2019

[^Top](#)

### 8.9.3: Hand Operating a Spring Switch Before Making a Trailing Movement

#### A. With Facing Point Lock

When a train is stopped by a signal governing trailing movement through a spring switch and the switch is equipped with a facing point lock, operate the switch by hand. Do not return the switch to normal position until after movement is complete.

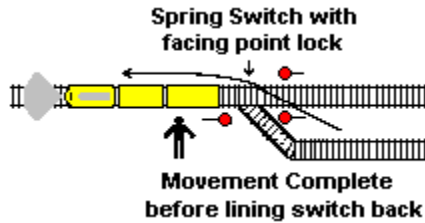

[Diagram A]

#### B. Without Facing Point Lock

Before a train makes a trailing movement through a spring switch not equipped with a facing point lock, and only hand operation can establish block signal protection, line the switch for the intended route. Return the switch to normal position after leading wheels have passed both insulated joints.

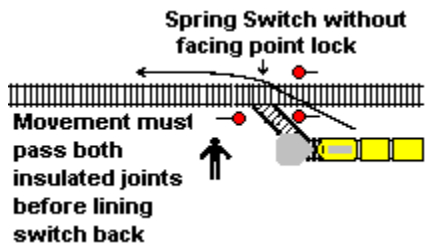

[Diagram B]

#### Rule Updated Date

October 26, 2012

[^Top](#)

### 8.9.4: During Snow or Ice Storms

During snow storms, ice storms, or other conditions that may prevent a spring switch from functioning properly, avoid making a trailing movement through the spring switch until the switch has been lined by hand for the movement.

#### Rule Updated Date

April 7, 2010

[^Top](#)

### 8.9.5: Spiking Spring Switch

A spring switch that is spiked must be protected.

**Rule Updated Date**

April 7, 2010

[^Top](#)

**8.9.6: Approaching a Spring Switch in Non-Signaled Territory**

A train in non-signaled territory must approach the facing points of a spring switch prepared to stop until:

- A switch point indicator shows that the switch is properly lined.  
**or**
- A distant signal displays clear.

**Rule Updated Date**

April 7, 2010

[^Top](#)

**8.10: Switch Point Indicator**

<b>Aspect</b>	<b>Indication</b>
<b>Green</b>	Switch points fit properly in normal position.
<b>Yellow</b>	Switch points fit properly in reverse position.
<b>Red</b> or Dark	Stop and inspect switch.

**Rule Updated Date**

April 7, 2010

[^Top](#)

**8.11: Switches in Sidings**

The normal position of switches connecting any track, except the main track, to a siding is lined and locked or secured for movement on the siding.

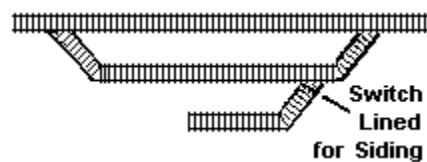

[Diagram A]

**Rule Updated Date**

April 7, 2010

[^Top](#)

**8.12: Hand-Operated Crossover Switches**

Both switches must be in corresponding position before moving over or through a crossover switch and must remain in corresponding position until movement is complete.

Crossover switches may be out of corresponding position when:

- One crew is using both tracks connected by the crossover during continuous switching operations.
- Providing blue signal or inaccessible track protection in Rule 6.14 (Restricted Limits), Rule 6.28 (Movement on Other than Main Track) or non-signaled Rule 6.13 (Yard Limits) territory.
- Performing maintenance, testing or inspection in signaled territory.

Crossover switches must be left lined in corresponding position. Crossover switches connected to a main track or siding must be left lined in normal position.

**Rule Updated Date**

April 7, 2010

[^Top](#)

**8.13: Scale Track Switches**

When scales are not in use, line switches for dead rails where provided.

**Rule Updated Date**

April 7, 2010

[^Top](#)

**8.14: Conflicting Movements Approaching Switch**

When conflicting movement is closely approaching a switch, the track must not be fouled or the switch operated. Except at a spring switch, trains must not foul a main track or signaled track or pass beyond an insulated joint at the clearance point until the switch connected with the movement is properly lined.

Crossover switches must not be unlocked or lined for crossover movement when another movement is approaching or passing over either switch.

**Rule Updated Date**

April 7, 2010

[^Top](#)

## **8.15: Switches Run Through**

Do not run through switches, other than spring switches or variable switches. If a rigid type switch is run through, it is unsafe and must be protected by spiking the switch, unless a trackman or other competent employee takes charge.

An engine or car that partially runs through a switch must continue movement over the switch. The engine or car must not change direction over a damaged switch until it has been spiked or repaired.

### **Rule Updated Date**

April 7, 2010

[^Top](#)

## **8.16: Damaged or Defective Switches**

Report a switch that is damaged or defective to the train dispatcher, yardmaster, or supervisor in charge. Tag the switch, spike it if necessary, unless trackman or other employee takes charge. If the switch cannot be made safe, provide protection at once.

### **Rule Updated Date**

April 7, 2010

[^Top](#)

## **8.17: Avoid Sanding over Movable Parts**

When possible, avoid using sand over movable parts of an interlocking, retarders, spring switches, variable switches, or power-operated switches.

### **Rule Updated Date**

April 7, 2010

[^Top](#)

## **8.18: Variable Switches**

Trailing point movements may be made over a variable switch from either track, regardless of the position of the switch points.

When making a trailing point movement and the switch is not lined for such movement, make sure all wheels of the leading car or unit clear the switch points before changing direction.

During snow storms, ice storms, or other conditions that may prevent a variable switch from functioning properly, avoid making a trailing point movement through a variable switch until it has been lined by hand for movement.

### **Rule Updated Date**



April 7, 2010

[^Top](#)

## 8.19: Automatic Switches

The location of automatic switches will be designated in the timetable. When movement authority requires a train to stop at an Automatic Switch location, stop must be made before any part of a train passes the signal governing movement over the Automatic Switch. To operate an automatic switch to enter the siding, a crew member must do the following:

- Stop the leading end of movement within 200 feet of the absolute signal that governs movement over the switch.
- Operate the push button on the signal mast.

After 40 seconds, the signal will display a restricting indication when the switch is lined for movement into the siding.

When the signal that governs movement over an automatic switch displays a Stop indication, the switch must be operated by hand before proceeding.

### Operating an Automatic Switch by Hand

To operate an automatic switch by hand, the crew member must stop the train for the signal that governs movement over the switch and then do the following:

- Unlock the switch lock.
- Place the selector lever in the HAND position.
- Operate the hand throw lever until the switch points move when the lever is moved.
- Line the switch for the intended route.
- Do not return the selector lever to the POWER position until at least one unit or car has passed over the switch.

After switch is placed in hand position, signal governing movement over the switch will display Stop indication and movements will be governed by hand signals.

When the switch is returned to the POWER position and movement over the switch is complete, the switch will automatically return to its normal position.

**Entering Main Track.** A train that is about to enter the main track and is authorized to proceed must move past the overlap sign. Further movement must not be made until the signal governing movement over the switch displays a proceed indication. If the signal does not display a proceed indication within 5 minutes, a crew member must operate the switch by hand as specified in Rule 9.17 (Entering Main Track at Hand-Operated or Spring Switch), waiting an additional 5 minutes, if necessary.

**When automatic switches are operated by hand, all rules governing hand-operated switches apply, except cars must not be dropped over the switches.**

### Rule Updated Date

April 7, 2010

[^Top](#)

## 8.19.1: Radio Controlled Switches

The location of Radio Controlled Switches (RCS) and operating instructions will be designated in timetable special instructions. When movement authority requires a train to stop at a RCS location, stop must be made before any part of a train passes the signal governing movement over the RCS.

At locations where radio controlled switches are installed, the following instructions apply.

RCS locations are equipped with:

- Dual control switch machines.
- Bi-directional switch point indicators per Rule 8.10.
- Occupancy (OS) circuits with limits marked by signs reading "Begin OS" and "End OS".

Signs reading "Switch Control" are located approximately 2 miles in advance of RCS locations.

### Operating Instructions:

1. Upon passing a "Switch Control" sign use the radio keypad to transmit the proper sequence (designated in the timetable) to request the desired switch position and receive radio transmitted verbal confirmation of switch alignment at that location.
2. Once radio confirmation of proper switch alignment has been received, movement through the RCS location must be made within 10 minutes of confirmation or the movement must approach the RCS location prepared to stop.
3. If radio confirmation of proper switch alignment is not received, movement must approach the RCS location prepared to stop until the switch point indicator can be clearly seen to indicate proper switch alignment. Notify the train dispatcher that radio confirmation was not received.

### Stop and Inspect Switch

If the radio message received is "Switch Not Lined" or no radio message is received and the switch point indicator continues to display an indication to stop and inspect switch:

1. Movement must stop before entering the OS circuit limits.
2. After stopping, the RCS may be operated by unlocking the box on the side of the signal bungalow and using the push-button.
3. After push-button operation is attempted, if the switch point indicator continues to display an indication to stop and inspect switch, employee must operate the switch by hand as outlined in Rule 9.13.1 (Hand Operation of Dual Control Switches).

**Note:** If the switch point indicator can be clearly seen to indicate proper switch alignment, the movement may proceed without stopping. Notify the train dispatcher of malfunction.

### Movement Completely Through a Radio Controlled Switch Location

After movement has been made through a RCS location, the switch point indicator will display an indication to stop and inspect switch and the switch will remain in the normal position. If switch was reversed, it will return to the normal position.

### Route Change

If necessary to change the route that was originally requested, movement must stop outside the OS circuit limits and:

- Wait 15 minutes and then enter the proper sequence to line the switch for the desired route.
- Wait 15 minutes and then operate the push-button on the signal bungalow to line the switch for the desired route.  
or
- Operate the switch by hand as outlined in Rule 9.13.1 (Hand Operation of Dual Control Switches) to line the switch for the desired route.

#### **Additional Instructions**

The RCS will not operate if the OS circuit at the RCS location is occupied. A proper sequence or push-button request must be made and confirmation of proper switch alignment must be received before movement enters the OS circuit limits at the RCS location.

#### **Rule Updated Date**

April 1, 2015

#### **System Special Instructions**

Effective Date: April 1, 2015

[^Top](#)

## **8.20: Derail Location and Position**

Employees in train, engine, and yard service must know the location of all fixed derails that affect their movement. Train or engine moving on or entering tracks where fixed derails are located, must stop at least 100 feet from derail in derailing position. Movement must not continue until the derail is placed in the non-derailing position. Do not leave equipment within 50 feet of a derail in the derailing position, when practicable. However, the distance restrictions will not apply in engine servicing or car shop repair areas.

Do not make a movement over a derail in derailing position.

Siding having hand-thrown derails will have derail locked in the non-derailing position, except when engines or cars are left unattended on siding. On auxiliary tracks other than siding, except when derails are placed in non-derailing position to permit movement, make sure they are always in derailing position regardless of whether cars are on the track they are protecting. Lock all derails equipped with a lock.

Derails that are used in conjunction with worker protection must be in the derailing position with proper flag displayed only when their use is required for such protection. When their use is not required for protection:

- Remove portable derails, then remove flag.  
or
- Lock fixed derails in non-derailing position with an effective locking device, then remove (take down) flag.

#### **Rule Updated Date**

March 1, 2024

#### **System Special Instructions**

Effective Date: April 1, 2015

**General Order**

Effective Date: March 1, 2024

[^Top](#)

## Union Pacific Rules

### UPRR - General Code of Operating Rules

## **9.0: BLOCK SYSTEM RULES**

- [9.1: Signal Aspects and Indications](#)
- [9.2: Location of Signals](#)
- [9.3: What Signals Govern](#)
- [9.4: Improperly Displayed Signals or Absent Lights](#)
- [9.5: Where Stop Must Be Made](#)
- [9.5.1: Changing Established Route](#)
- [9.5.2: Protection If Signal Appliance or Track Is Damaged](#)
- [9.5.3: Protection During Repairs](#)
- [9.5.4: Authority to Proceed](#)
- [9.5.5: Reporting Delays](#)
- [9.5.6: Track Occupancy Indicator](#)
- [9.6: Change of Signal Indication](#)
- [9.7: Failure to Display Most Restrictive Indication](#)
- [9.8: Next Governing Signal](#)
- [9.9: Train Delayed Within a Block](#)
- [9.9.1: Approach to Automatic Interlocking](#)
- [9.10: Initiating Movement Between Signals](#)
- [9.11: Movement from Signal Requiring Restricted Speed](#)
- [9.12: Stop Indications](#)
- [9.12.1: CTC Territory](#)
- [9.12.2: Manual Interlockings](#)
- [9.12.3: Automatic Interlockings](#)
- [9.12.4: ABS Territory](#)
- [9.13: When Instructed to Operate Dual Control Switches by Hand](#)
- [9.13.1: Hand Operation of Dual Control Switches](#)
- [9.13.2: Performing Switching](#)
- [9.14: Movement with the Current of Traffic](#)
- [9.14.1: Reporting Clear of a Track Having a Current of Traffic](#)
- [9.14.2: Controlled Block System \(CBS\)](#)
- [9.15: Track Permits](#)
- [9.15.1: Issuing Track Permits](#)
- [9.15.2: Clearing Track Permits](#)
- [9.16: Stop and Proceed Indication](#)
- [9.17: Entering Main Track at Hand-Operated or Spring Switch](#)

- [9.17.1: Signal Protection in ABS by Lining Switch](#)
- [9.18: Electrically Locked Switches and Derails](#)
- [9.19: Leaving Equipment in Signal System](#)
- [9.20: Clear Track Circuits](#)
- [9.21: Overlap Circuits](#)
- [9.22: Standing on Sanded Rail](#)
- [9.23: Suspension of Block System](#)
- [9.23.1: Guidelines While Block System Is Suspended](#)
- [9.24: Call Lights](#)

## 9.1: Signal Aspects and Indications

Distant, block, and interlocking signal aspects and indications are shown in the special instructions.

Signal aspects are identified by the position of semaphore arms, color of lights, flashing of lights, position of lights, or any combination. Aspects may be qualified by marker plate, number plate, letter plate, or marker light.

Signals may display color light aspects or semaphore arms and color lights.

### Rule Updated Date

April 7, 2010

[^Top](#)

## 9.2: Location of Signals

When viewed from the train, block and interlocking signals are generally to the right of the track. However, they may be located to the left or above the track. To display indications for two tracks, two bracketed signals may be located on a supporting mast. The signal to the right governs the track to the right, and the signal to the left governs the track to the left.

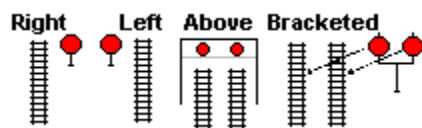

[Diagram A]

### Rule Updated Date

April 7, 2010

[^Top](#)

## 9.3: What Signals Govern

Block signals, cab signals, or both govern the use of blocks.

Interlocking signals govern the use of interlocking routes. Where a track is signaled beyond the interlocking limits in the direction of movement, the interlocking signal is also a block signal.

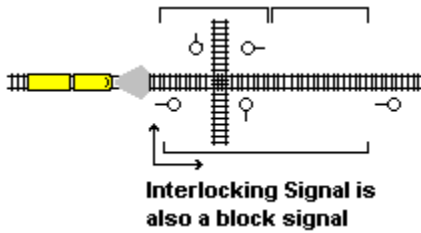

[Diagram A]

All other rules, where required, remain in effect when complying with the indication of block and interlocking signals.

#### **Rule Updated Date**

April 7, 2010

[^Top](#)

### **9.4: Improperly Displayed Signals or Absent Lights**

Except as shown in block, cab, and interlocking signal aspects in the special instructions, if a light is absent, a white light is displayed where a colored or lunar light should be, or additional colored or lunar lights are displayed, regard a block or interlocking signal as displaying the most restrictive indication it can give. However, when the semaphore arm position is plainly seen, that aspect will govern.

#### **Rule Updated Date**

April 7, 2010

[^Top](#)

### **9.5: Where Stop Must Be Made**

When movement is being made beyond a block signal requiring a train to be prepared to stop at the next signal, the stop must be made before any part of a train passes the block signal requiring the train to stop.

If a train overruns any block signal that requires it to stop, the crew must:

- Warn other trains at once by radio.
- Stop the train immediately.
- Report it to the train dispatcher.

#### **Rule Updated Date**

April 7, 2010

[^Top](#)

### **9.5.1: Changing Established Route**

Except to avoid an accident, after a controlled signal has been cleared for a closely approaching train, the control operator must not change the signal to a Stop indication before the approaching train's engineer has confirmed that a Stop indication can be complied with at that location. Do not establish or authorize a conflicting route until communicating with the approaching train's crew and ensuring that the train has stopped clear of the conflicting route.

The control operator must not establish a conflicting route into an occupied block or interlocking limits, or authorize a conflicting movement, unless it is safe to do so.

The control operator must avoid operating the device controlling a switch, derail, movable point frog, or lock when any portion of a train is on or closely approaching the equipment.

#### **Rule Updated Date**

April 7, 2010

[^Top](#)

### **9.5.2: Protection If Signal Appliance or Track Is Damaged**

If a signal or signal appliance functions improperly or the track is damaged, signals that govern movements on affected routes must display a Stop indication. No movements on such routes may be permitted until track and signal appliances are examined and movement can occur safely.

#### **Rule Updated Date**

April 7, 2010

[^Top](#)

### **9.5.3: Protection During Repairs**

Within CTC limits or within manual interlocking limits (unless track bulletin Form B is in effect), when a switch, movable point frog, derail, or signal is under repair or is disconnected, or when the track is obstructed or removed from service, display Stop indications for all affected routes. In addition, block or mark any controls to prevent their operation.

Maintenance forces must contact the control operator before beginning repairs, disconnecting equipment, obstructing the track, or removing the track from service. Switches, movable point frogs, and derails must be spiked or secured in the required position if any movement over them occurs before repairs are complete.

#### **Rule Updated Date**

April 7, 2010

[^Top](#)

### **9.5.4: Authority to Proceed**



Except when a signal is used to provide protection within CTC limits or at manual interlockings, control operators must not give hand signals or otherwise authorize movement beyond a Stop indication when a proceed indication can be displayed for the movement.

At manual interlockings, control operators must give hand signals so that crew members can understand the signals and know which train they are intended for.

**Rule Updated Date**

December 18, 2019

**System Special Instructions**

Effective Date: April 1, 2020

[^Top](#)

**9.5.5: Reporting Delays**

When a controlled signal displays a proceed indication, notify the control operator immediately if movement cannot occur promptly.

**Rule Updated Date**

April 7, 2010

[^Top](#)

**9.5.6: Track Occupancy Indicator**

Where track occupancy indicators are located, employees must observe the indication before fouling a circuit or changing the derail or a main track switch.

When an occupied indication is displayed, trains or equipment must not foul the main track unless movement is properly protected.

Track occupancy indications do not authorize movement or relieve employees from protecting movements as required by the rules.

**Rule Updated Date**

April 7, 2010

[^Top](#)

**9.6: Change of Signal Indication**

If a signal displaying a proceed indication changes to an indication requiring a train to stop, the train must stop at once. Report such a signal change to the train dispatcher.

**Rule Updated Date**

April 7, 2010

[^Top](#)

**9.7: Failure to Display Most Restrictive Indication**

When a block is occupied, or when a switch protected by a signal is changed from its normal position and that signal fails to display its most restrictive indication, regard the signal as displaying Stop. The train must stop immediately, and employees must warn others by radio of the exact location and status of the train. Contact the train dispatcher or control operator and do not move the train without permission.

**Rule Updated Date**

April 7, 2010

[^Top](#)

**9.8: Next Governing Signal**

A train may comply with the next signal's indication when its aspect can be clearly seen and the signal governs the track where movement is occurring or will be made.

When the PTC display indicates the next governing signal will not require a stop, the train may proceed prepared to enter the next block complying with the signal indication governing that block.

This does not apply when a rule or previous signal indication requires movement at restricted speed.

**Rule Updated Date**

September 19, 2018

**System Special Instructions**

Effective Date: May 10, 2019

[^Top](#)

**9.9: Train Delayed Within a Block**

If a train has entered a block on a proceed indication that does not require restricted speed, and the train stops or its speed is reduced below 10 MPH, the train must:

## A. ABS

**Proceed at restricted speed. The train must maintain this speed until the next signal is visible, that signal displays a proceed indication, and the track to that signal is clear.**

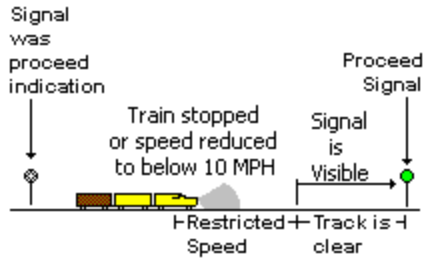

[Diagram A]^^

## B. CTC or Manual Interlocking Limits

**Proceed prepared to stop at the next signal until the next signal is visible and that signal displays a proceed indication.**

Passenger trains operating in push/pull service must not exceed 40 MPH until the next signal is visible and that signal displays a proceed indication.

## C. ACS

**Operate according to cab signal indication.**

## D. PTC

**When the PTC display indicates the next governing signal will not require a stop, the train may proceed prepared to enter the next block complying with the signal indication governing that block.**

### Rule Updated Date

December 18, 2019

### System Special Instructions

Effective Date: December 18, 2019

[^Top](#)

## 9.9.1: Approach to Automatic Interlocking

A train must proceed prepared to stop at the interlocking signal when:

- Moving below 25 MPH and passing a signal that governs the approach to an automatic interlocking.
- or
- Speed is reduced to below 25 MPH after passing a signal that governs the approach to an automatic interlocking.

The train must continue to move prepared to stop at the interlocking signal until the train reaches a point approximately 1,000 feet from that signal. If the interlocking signal then indicates proceed, the train may resume speed.

**Rule Updated Date**

April 7, 2010

[^Top](#)

**9.10: Initiating Movement Between Signals**

When one of the following occurs, move at restricted speed until the leading wheels have passed the next governing signal or the end of the block system:

- The train enters a block with no governing signal.

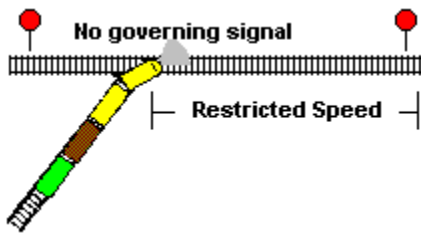

[Diagram A]

- The previous signal indication is unknown.
- Movements in the opposite direction from which the block was entered.

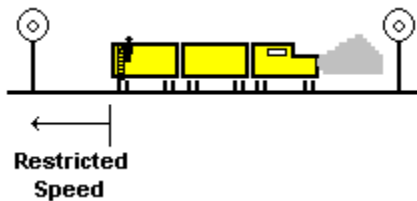

[Diagram B]

**Exception**

If a train is within ACS or ATC territory with operative cab signals, the train may operate according to the cab signal indication.

**Rule Updated Date**

April 7, 2010

[^Top](#)

**9.11: Movement from Signal Requiring Restricted Speed**

When a train passes a signal requiring movement at restricted speed, the train must move at restricted speed until its leading wheels have passed the next governing signal or the end of the block system.

**Rule Updated Date**

July 11, 2023

**System Special Instructions**

Effective Date: July 11, 2023

[^Top](#)

## 9.12: Stop Indications

**Rule Updated Date**

April 7, 2010

[^Top](#)

### 9.12.1: CTC Territory

At a signal displaying a Stop indication, if no conflicting movement is evident, the train will be governed as follows:

- A crew member must immediately contact the control operator unless the train is:
  - Within track and time limits.
  - or
  - Entering track and time limits from any point other than either end of the track and time limits.
- Before authorizing the train to proceed, the control operator must know that the route is properly lined and no conflicting movement is occupying or authorized to enter the track between that signal and the next absolute signal governing movement or the end of CTC where applicable.
- When the train receives these instructions, "After stopping, (train) at (location) has authority to pass signal displaying Stop indication," specifying the route where applicable. The train must move at restricted speed.
- If the signal governs movement over a drawbridge, a crew member must verify that the bridge is in the proper position for the train to pass.

#### Exception

**Conflicting Movement.** When the control operator has stopped a conflicting movement, he may then authorize another train to proceed in the same limits, advising both crews of movement to be made. If the stopped movement is later permitted to proceed, that train must move at restricted speed until its leading wheels have passed the next governing signal or the end of the block system.

**Rule Updated Date**

April 1, 2015

[^Top](#)

### 9.12.2: Manual Interlockings

At a signal displaying a Stop indication, if no conflicting movement is evident, the train will be governed as follows:

- A crew member must immediately contact the control operator.
- Before authorizing the train to proceed, the control operator must know that the route is properly lined and no conflicting movement is occupying or authorized to enter the track between that signal and the next absolute signal governing movement or the end of interlocking limits where applicable.
- The control operator may authorize the train to proceed by using hand signals or the following instructions, "After stopping, (train) at (location) has authority to pass signal displaying Stop indication," specifying the route where applicable. The train must move at restricted speed.
- If the signal governs movement over a drawbridge, a crew member must verify that the bridge is in the proper position for the train to pass.

Before proceeding into or continuing in CTC territory, the manual interlocking control operator must be sure that the CTC control operator has given authority to proceed.

#### Exception

**Conflicting Movement.** When the control operator has stopped a conflicting movement, he may then authorize another train to proceed, advising both crews of movements to be made. If the stopped movement is later permitted to proceed, that train must move at restricted speed until its leading wheels have passed the next governing signal or the end of the block system.

#### Rule Updated Date

April 7, 2010

[^Top](#)

### 9.12.3: Automatic Interlockings

At a signal displaying a Stop indication, the crew will be governed by instructions in the release box, special instructions, or other instructions. After complying with the instructions that allow the train to proceed, if signal continues to display a Stop indication, the train must move at restricted speed. However, if there is a conflicting movement, the train must not proceed until the movement has passed or stopped, and both crews agree on the next movement.

#### Rule Updated Date

April 7, 2010

[^Top](#)

### 9.12.4: ABS Territory

At a signal displaying a Stop indication outside interlocking limits, the train will be governed as follows:

## **A. Main Track**

On a main track, except where Rule 9.14 ( Movement with the Current of Traffic) is in effect, after stopping, a train authorized beyond the signal may proceed at restricted speed under any of the following conditions:

1. Authority beyond the signal is joint with other trains or employees.
2. To permit an engine, with or without cars, to couple to its train or to a standing cut of cars, if the track between the engine and cars is clear.
3. A crew member has contacted the train dispatcher and obtained permission to pass the Stop indication. However, if the train dispatcher cannot be contacted, move 100 feet past the signal, wait 5 minutes, then proceed at restricted speed.

## **B. Movement with the Current of Traffic**

On a main track where Rule 9.14 (Movement with the Current of Traffic) is in effect, after stopping, a crew member must contact the train dispatcher or control operator and obtain permission to pass the Stop indication, then proceed at restricted speed. However, if the signal governs movement to a single main track, comply with Rule 9.17 (Entering Main Track at Hand-Operated or Spring Switch), then proceed at restricted speed.

## **C. Siding or Other Track**

If the signal governs movements from a siding or other track to the main track, comply with Rule 9.17 (Entering Main Track at Hand-Operated or Spring Switch), then proceed at restricted speed.

## **D. Control Point Locations**

At control point locations, if no conflicting movement is evident, a crew member must immediately contact the control operator for authority to pass the Stop indication unless the control point is within the trains track permit limits.

### **Application:**

Examples of joint authority beyond the signal in Part A 1: Work Between, Yard Limits, Restricted Limits.

### **Rule Updated Date**

April 1, 2015

### **System Special Instructions**

Effective Date: April 1, 2015

[^Top](#)

## **9.13: When Instructed to Operate Dual Control Switches by Hand**

If the control operator cannot line the dual control switch to the desired position, or the control machine does not indicate that the switch is lined and locked, before authorizing movement the control operator and crew must have a clear understanding specifying:

- The control point.
- Route.

- Switch(s) that must be operated by hand.

The control operator may then authorize movement past the Stop indication and instruct the employee to operate the switch(s) by hand.

Movement may then proceed as authorized only after a clear understanding is reached with all crew members specifying the control point, route and switch(s) that must be operated by hand.

Before passing over a switch specified by the dispatcher, the train must stop and the employee must operate the switch by hand as outlined in Rule 9.13.1 (Hand Operation of Dual Control Switches). After at least one unit or car has passed over the switch points, the employee must return the switch to power unless otherwise instructed by the control operator. If any additional facing point switches are in the route, the crew must stop and verify the switches are lined for the intended route and the switch points fit properly.

#### **Rule Updated Date**

May 2, 2016

#### **System Special Instructions**

Effective Date: May 2, 2016

[^Top](#)

### **9.13.1: Hand Operation of Dual Control Switches**

An employee must get permission from the control operator to operate a dual control switch by hand. Operate the switch as follows:

- Unlock the switch lock.
- Place the selector lever in the HAND position or remove the hand crank from the holder.
- Operate the hand throw lever until the switch points are seen to move when the lever is operated, even if the switch is lined for the intended route.
- Line the switch for the intended route, or insert the crank on the shaft and turn the crank as far as it will turn until the switch is in the desired position. Remove the crank from the shaft, but do not return it to the crank holder.
- Return the switch to power by restoring the selector lever to the POWER or MOTOR position and lock. Or, return the crank to the holder and secure it with the switch lock. Notify the control operator after power to the switch is restored.

When the selector lever is in the HAND position or the crank has been removed from the holder, signals governing movements over the switch will display Stop indication, and movements will be governed by the employee operating the switch. Notify the engineer, if possible, when the switch is in hand operation and when it has been restored to power operation.

For other types of switch machines, follow the above procedure using the instructions for operation posted at the switch or by special instructions.

#### **Rule Updated Date**

April 1, 2015



[^Top](#)

## **9.13.2: Performing Switching**

When necessary to place a dual control switch in hand operation to perform switching, the crew must:

- Complete a job briefing with the control operator on moves to be made.
- Receive authority to enter the control point.
- Receive permission to place the switch in hand operation.

Crew will then comply with Rule 9.13.1, except do not return switch to power until final movement has been made over the switch.

Notify the control operator when switch has been returned to power. Further movements must be made by signal indication or as authorized by the control operator.

### **Rule Updated Date**

May 5, 2021

### **System Special Instructions**

Effective Date: May 5, 2021

[^Top](#)

## **9.14: Movement with the Current of Traffic**

On tracks designated in the timetable, trains will run with the current of traffic, if the train dispatcher or control operator gives authorization or a controlled signal indicates proceed.

### **Rule Updated Date**

April 1, 2015

[^Top](#)

### **9.14.1: Reporting Clear of a Track Having a Current of Traffic**

A train without a crew member on the rear and operating on a track having a current of traffic may report clear of the limits or report having passed a specific location only when it is known the train is complete. This must be determined by one of the following ways:

- The rear of the train has a rear-end telemetry device, and air pressure on the head-end device indicates brake pipe continuity.
- An employee verifies the marker is on the rear of the train.
- A crew member can observe the rear car of the train on which the marker is placed.

- The train is stopped and an inspection verifies that the marker is on the rear car of the train.
- A trackside warning detector transmits an axle count for the train, and axle count duplicates the axle count transmitted by the previous trackside warning detector.

In addition, a train clearing in a siding or other track must comply with requirements outlined in Rule 8.3 (Main Track Switches) before reporting clear of the limits.

#### **Rule Updated Date**

April 7, 2010

[^Top](#)

### **9.14.2: Controlled Block System (CBS)**

On tracks designated in the timetable, movements will run in the direction specified by verbal authority from the train dispatcher or a controlled signal displaying a proceed indication. This authority will establish the current of traffic for the movement. Before granting authority, the train dispatcher must know that conflicting movements are protected.

A train must not enter or occupy any track in CBS limits unless:

- A controlled signal indicates proceed.
- or
- Verbal authority is granted.

A movement must proceed only in the direction authorized unless authority is granted by Rule 9.15 (Track Permits).

A movement authorized in one direction must report to the train dispatcher when it has cleared the main track within CBS limits. A movement that clears the main track within CBS limits must not reenter that track without new authority unless within Track Permit limits.

In CBS limits, Rule 9.15 (Track Permits) is in effect.

#### **Rule Updated Date**

April 1, 2015

#### **System Special Instructions**

Effective Date: April 1, 2015

[^Top](#)

### **9.15: Track Permits**

On tracks designated in the timetable, a track permit will authorize a train, track car, machine, or employee to occupy the main track or tracks between specific points. The track permit must be issued by a designated control operator under the direction of the train dispatcher. Within these limits, movements may be made in either direction according to signal indication.

Limits designated by a switch extend only to the signal governing movement over the switch, unless otherwise designated.

A train must obtain authority to pass a controlled signal displaying Stop indication to enter track permit limits. Within track permit limits a train, after stopping, may pass a signal displaying Stop indication at restricted speed without further authority, except when signal governs movement at an interlocking.

#### **Rule Updated Date**

April 7, 2010

[^Top](#)

### **9.15.1: Issuing Track Permits**

The track permit may only be issued when:

- Limits are clear.
- Limits are occupied by the train, track car, machine, or employee who will receive the track permit.
- Limits are occupied by a train, track car, machine, or employee holding a track permit.
- or
- All trains moving on signal indication without a track permit have passed the location where the track will be fouled.

The track permit limits must be protected by controlled signals. The designated control operator must know the following before issuing a track permit:

- Each controlled signal protecting the limits displays a Stop indication.
- Marking or blocking devices prevent displaying signals for movement into the limits.
- The designated control operator and each control operator who controls signals to protect the limits understand the limits, have provided protection, and have recorded the track permit on the prescribed form.

#### **Track Permit Acknowledgment**

Track permit authority must be recorded and repeated to the control operator. Acknowledgment must be received before being acted upon.

The employee will repeat the preprinted and information transmitted by the train dispatcher including what has been entered in the summary, "This authority has (total number) boxes marked: (individual box numbers)."

The control operator must maintain a record of the authority granted.

#### **More than One Track Permit**

If more than one track permit is in effect at any time within the same limits, all affected trains or employees must be notified.

Trains must move at restricted speed within these limits.

#### **Rule Updated Date**

April 1, 2015

## System Special Instructions

Effective Date: April 1, 2015

[^Top](#)

### 9.15.2: Clearing Track Permits

Marking or blocking devices must not be changed or removed until the limits have been released to the control operator.

Track permit limits must be cleared and reported clear to the control operator before time expires. If the track permit is released before time expires, all equipment must be clear of the limits and reported clear to the designated control operator. However, if no other track permit has been granted within the same limits, the train may request release of the track permit. Signal indications will then govern the train if the control operator verbally authorizes the release, specifying direction of movement if required.

When necessary to modify the expiration time, an employee and the control operator must communicate before the time expires to adjust the time granted. If the employee cannot contact the control operator and the time limit expires, authority is extended until the control operator is contacted.

Employees reporting clear of track permit authority must state:

- Their name or other identification.
- Track permit number being released.
- Limits being released.

#### Releasing Portion of Limits

When a crew member informs the control operator that the authority is released between two specific points, the authority is considered void between those points. This track release must begin at the outer limit of the authority.

#### Rule Updated Date

April 7, 2010

[^Top](#)

### 9.16: Stop and Proceed Indication

At a signal displaying a Stop and Proceed indication, the train will be governed as follows:

1. The train must stop, then proceed at restricted speed.  
or
2. The train may pass the signal at restricted speed without stopping to do any of the following:
  - a. Leave the main track when the switch is lined for movement and the track is clear from the signal to the clearance point.

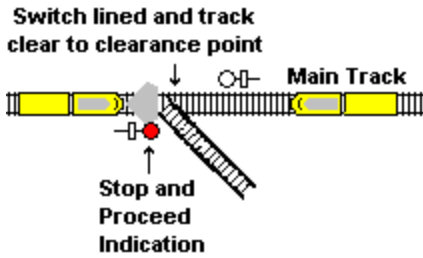

[Diagram A]

b. Continue on the main track when meeting or passing a train, and the main track is clear to the opposite end of the siding where a train is fouling the main track.

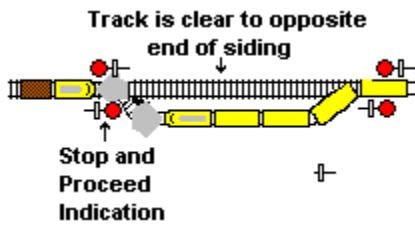

[Diagram B]

c. Permit an engine, with or without cars, to couple to its train or to a standing cut of cars, if the track between the engine and cars is clear.

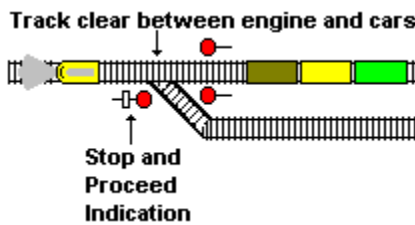

[Diagram C]

d. Enter a switch that is less than 1,000 feet beyond the signal, and the employee in charge of the switch has granted permission for movement.

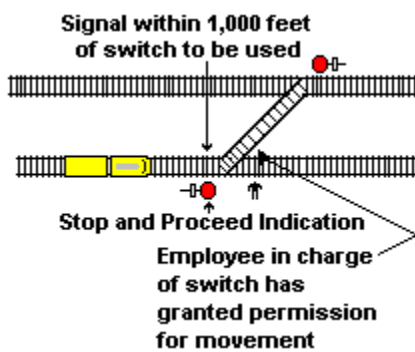

[Diagram D]

e. Continue on the main track when proceeding at restricted speed due to rule or previous signal indication.

f. Move within track and time, work and time, work between, track permit, or track out of service limits.

### Rule Updated Date

April 7, 2010

[^Top](#)

## 9.17: Entering Main Track at Hand-Operated or Spring Switch

Within CTC territory and manual interlocking limits, the control operator must authorize the train to enter the track at a hand-operated or spring switch where no governing signal exists. The control operator must verify that there are no conflicting movements before giving the authority.

In ABS territory, when authorized to enter the signaled track, a crew member or switch tender must open the switch and wait 5 minutes at the switch to establish block signal protection. If at the end of 5 minutes the employee does not hear or see movement approaching, the train may enter the signaled track. At a crossover, line the switch in the track the train is on, wait the 5 minutes, then line the other switch of the crossover.

### A. When Hand Operation of a Spring Switch or 5 Minute Wait Is Not Required

Waiting 5 minutes or operating the spring switch by hand is not required [unless prescribed by Rule 8.9 (Movement over Spring Switches)]^ under any of the following conditions:

1. Switch is equipped with an electric lock.
2. Track occupancy indicator indicates track is clear at locations specified in timetable special instructions.
3. Block signal governing movement to signaled track indicates proceed.
4. Block signals governing movements on the signaled track indicate that no train is approaching from either direction.

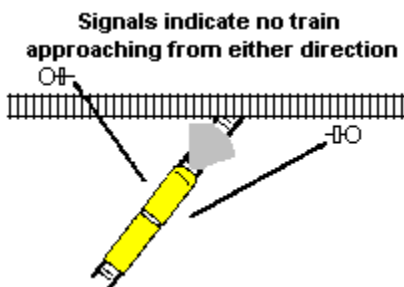

[Diagram A]^^^

- 5 Block to be entered is occupied by a train, engine, or car that is standing or moving away from the switch to be used.

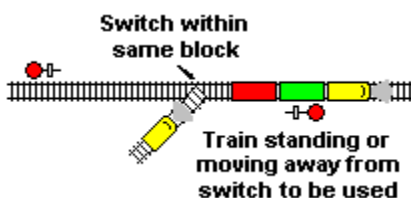

[Diagram B]^^^

- 6 Main track between siding switches is occupied by a train that has been met or a standing train that will be passed.

### Track occupied by train met or passed

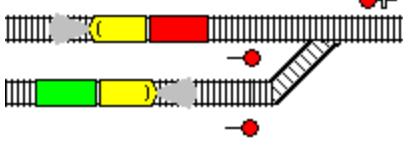

[Diagram C]^^^

- 7 Train is entering a main track outside of yard limits for authorized movement against the current of traffic.
- 8 Rule 6.14 (Restricted Limits) is in effect, provided movement does not occur beyond restricted limits for 5 minutes . after the main track circuit is fouled, unless a block signal displays a proceed indication.
- 9 Work and time authority is granted within DTC.
- 10 Track permit authorizes movement.
  - . or
- 11 Track warrant outside yard limits authorizes WORK BETWEEN two specific points.
- **Rule Updated Date**

April 1, 2015

### System Special Instructions

Effective Date: April 1, 2015

[^Top](#)

## 9.17.1: Signal Protection in ABS by Lining Switch

When a train or engine is within ABS limits and requires action as necessary to stop other trains, this may be provided by lining and locking a main track switch against movement at or beyond the point where the train or engine will stop movement or clear the main track.

If the switch is located within a block other than the one occupied, do not make movements until 5 minutes after the switch has been lined. Also, make sure no train or engine is between the switch and the train or engine being protected or is within or closely approaching the block where the switch is located.

Except where Rule 6.13 (Yard Limits) or Rule 6.14 (Restricted Limits) is in effect, a train must receive permission from the train dispatcher before crossing over to or obstructing another main track signaled for movement in one or both directions.

Train dispatcher must ensure that no other movements against the current of traffic have been or will be authorized. Crew members must notify the train dispatcher when their movement is clear of the other main track.

In addition, before crossing over or fouling a main track, trains must comply with the following:

- a Do not move until 5 minutes after lining the switch.
- b Locate the block signal that protects the switch against trains moving with the current of traffic. To move against the . current of traffic past that signal, pull the leading engine or car 100 feet beyond the signal. Wait 10 minutes before moving any further against the current of traffic. Then proceed at restricted speed.
- c

- . To move against the current of traffic beyond any further signals, obtain authority as outlined in Rule 14.6 (Movement Against the Current of Traffic) or Rule 15.3 (Authorizing Movement Against the Current of Traffic).

#### **Rule Updated Date**

April 7, 2010

[^Top](#)

### **9.18: Electrically Locked Switches and Derails**

Special instructions or instructions posted near the switch will govern the operation of switches and derails equipped with electric locks.

To enter a main track within interlocking or CTC limits, employees must not open the case of door or unlock an electrically locked switch or derail without track and time or authority from the control operator.

#### **Emergency Release**

If the electric lock includes an emergency release, do not break the seal on the release or operate the release without permission from the control operator or train dispatcher. However, when communication has failed, the seal may be broken and /or the release operated:

- To permit a train to leave the main track.  
**or**
- To permit a train that has authority to enter the main track. Train must not enter the main track until 5 minutes after the seal is broken and/or the release operated.

Notify the control operator or train dispatcher when the seal has been broken and/or the emergency release operated.

#### **Rule Updated Date**

April 7, 2010

[^Top](#)

### **9.19: Leaving Equipment in Signal System**

Engines, cars, or equipment must not be detached and left standing entirely between the opposing interlocking signals that govern movements at a railroad crossing at grade.



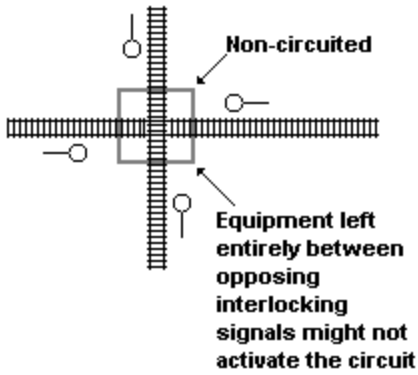

[Diagram A]

Do not depend upon track equipment, other than engines or cars to actuate block signals, interlocking signals, or highway crossing signals or to be under the protection of such signals.

**Rule Updated Date**

April 7, 2010

[^Top](#)

**9.20: Clear Track Circuits**

A train, engine, car, or equipment left standing on sidings or other tracks must be clear of insulated joints at clearance points.

**Rule Updated Date**

April 7, 2010

[^Top](#)

**9.21: Overlap Circuits**

Overlaps may be identified by overlap signs. A train on the main track at a meeting point must not pass an overlap sign location or open a switch within the overlap until the opposing train has entered the block.

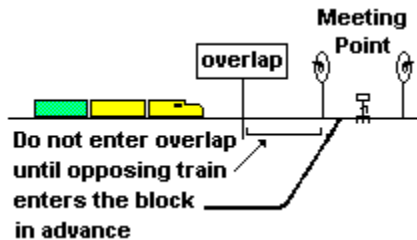

[Diagram A]

A preceding train must clear the overlap as soon as possible to avoid delaying a following train.

Unless otherwise instructed by the train dispatcher, a train on a siding at a meeting or passing point must not pass an overlap sign location until authorized to leave the siding.

**Rule Updated Date**

April 7, 2010

[^Top](#)

## **9.22: Standing on Sanded Rail**

Do not allow an engine with less than three cars, or cuts of four cars or less, to stand on a sanded rail.

### **Rule Updated Date**

April 7, 2010

[^Top](#)

## **9.23: Suspension of Block System**

When authorized, a track bulletin may suspend the block system or sections of it.

Do not suspend the block system or sections of it until all trains and control operators in the affected territory have been notified by track bulletin specifying the limits of the suspension.

Track bulletins issued to suspend the block system must not be delivered to trains entering the affected territory until the affected limits are clear of trains, or until the track bulletin has been transmitted or delivered to all trains within the limits.

### **Rule Updated Date**

April 7, 2010

[^Top](#)

### **9.23.1: Guidelines While Block System Is Suspended**

When a block system or sections of it are suspended, the following guidelines govern:

A Track Bulletin will specify, when applicable:

- The affected tracks and milepost limits of the suspension.
- The location(s) of flagmen who may authorize trains to enter or to proceed at intermediate locations within the suspended limits, specifying track(s) when necessary.
- The position of dual control switches at the end of multiple main tracks.
- Dual control switches that have been locked in hand operation for main track movement.
- Actions to be taken where automatic crossing warning devices are affected.
- When track warrants may be used to authorize movement.

#### **Crew members must:**

- Follow rules that apply to non-signaled territory and not exceed 59 MPH for passenger trains or 49 MPH for other trains.

- Disregard extinguished or illuminated block and interlocking signals, unless specified by track bulletin, except when those signals:
  - Govern movements over railroad crossings at grade.
  - Are connected with trackside warning detectors.
- Approach the beginning and end of the suspended limits prepared to stop. When suspension ends at a block signal identified as in service, trains must approach that signal prepared to stop until its aspect can be clearly seen.
- If suspension begins at an in service control point, signal indication will only authorize movement through the control point, not beyond it.
- If suspension does not end at a signal identified as in service, trains leaving the limits and moving into block system territory must move at restricted speed to the first signal in service beyond the limits.

### **Movements over Railroad Crossings at Grade and Drawbridges:**

- Signals that govern movement over railroad crossings at grade and drawbridges must be regarded as displaying a Stop indication, regardless of the aspect displayed, unless the track bulletin specifies that the signals are in service or flagman at that location authorizes movement.
- Crew members must not rely on time release or key controller operation as adequate protection to move over the crossing, unless instructed that they are in service.

### **Dual Control Switches:**

Unless notification has been received from the train dispatcher that dual control switches are:

- Locked in hand operation and are lined for intended movement.
- or
- Attended by a flagman;

Trains must stop and crew member must:

- Hand operate and lock dual control switches for main track movement.
- Leave switches locked in hand operation.
- Notify the train dispatcher that switches have been locked in hand operation and lined for main track movement.

Remote control switches not equipped for hand operation will be spiked or clamped and all concerned notified.

### **Spring Switches:**

Spring switches removed from service must be spiked and those concerned notified. If spring switches are left in service, trains making facing point movements must be prepared to stop and test the switch, unless it is known that the switch is properly lined for the diverging route.

**Block System Returned to Normal:**

Train Dispatcher must notify crew members within the affected territory before permitting other trains to enter the limits when the block signal system will be returned to normal operation.

**Rule Updated Date**

April 1, 2015

**System Special Instructions**

Effective Date: April 1, 2015

[^Top](#)

**9.24: Call Lights**

When a call light is on, any employee who sees it, unless the employee is on a moving train, must contact the control operator immediately.

**Rule Updated Date**

April 7, 2010

[^Top](#)

## [Union Pacific Rules](#)

### [UPRR - General Code of Operating Rules](#)

## **10.0: RULES APPLICABLE ONLY IN CENTRALIZED TRAFFIC CONTROL (CTC)**

- [10.1: Authority to Enter CTC Limits](#)
- [10.2: Clearing Through Hand-Operated Switches](#)
- [10.3: Track and Time](#)
- [10.3.1: Protection of Limits](#)
- [10.3.2: Protection of Machines, Track Cars, or Employees](#)
- [10.3.3: Joint Track and Time](#)
- [10.3.4: Track and Time Acknowledgment](#)

### **10.1: Authority to Enter CTC Limits**

CTC limits are designated in the timetable. Sidings within CTC limits are controlled sidings and are governed by CTC rules. A train must not enter or occupy any track where CTC is in effect unless a controlled signal displays a proceed indication or the control operator authorizes:

- Movement past a Stop indication under Rule 9.12.1 (CTC Territory).
- A train to enter track between block signals as follows: "(Train) at (location) has authority to enter (track) and proceed (direction)." After entering the track, the train is authorized to move only in the direction specified.

or

- Track and Time under Rule 10.3 (Track and Time).

### **Signal Governing Movement Over a Hand-Operated Switch**

If a signal governs movement over a hand-operated switch that is not electrically locked, the control operator must authorize the train to enter or occupy any track where CTC is in effect before the switch is opened. After the switch is opened, if the signal does not display a proceed indication, a crew member must wait 10 minutes at the switch. After the 10 minute wait if the signal does not display a proceed indication, move the train at restricted speed and notify the control operator.

However, if the block to be entered is occupied by its own standing train or when the hand-operated switch remains open, the movement may, after stopping, pass an absolute signal displaying a Stop indication without waiting 10 minutes and without contacting the control operator.

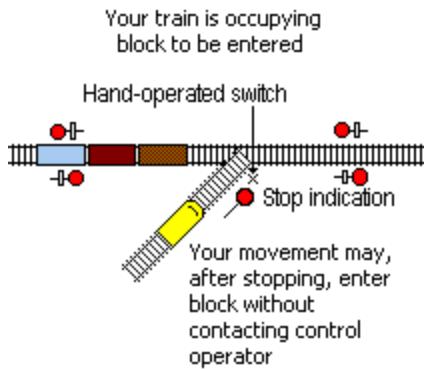

[Diagram A]^

### Rule Updated Date

July 2, 2013

[^Top](#)

## 10.2: Clearing Through Hand-Operated Switches

Where CTC is in effect, a train must not clear in any track at a hand-operated switch not equipped with an electric switch lock, except under one of the following conditions:

- Where the permanent maximum authorized speed does not exceed 20 MPH on the main track or a controlled siding equipped with an intermediate signal.

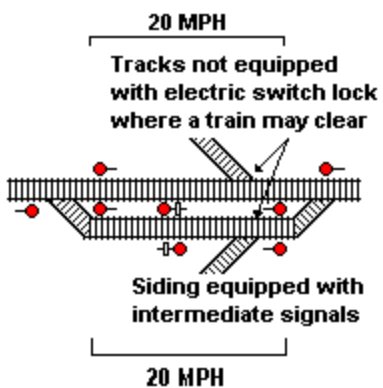

[Diagram A]

- Where the permanent maximum authorized speed does not exceed 30 MPH on a controlled siding not equipped with an intermediate signal.

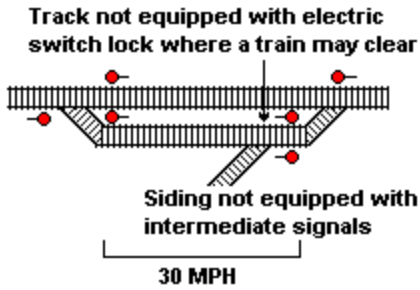

[Diagram B]

- Where a signal governs movement to a track where CTC is in effect.

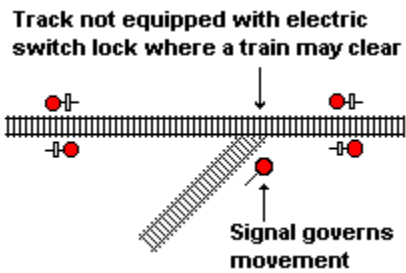

[Diagram C]

- When the hand-operated switch is kept open.

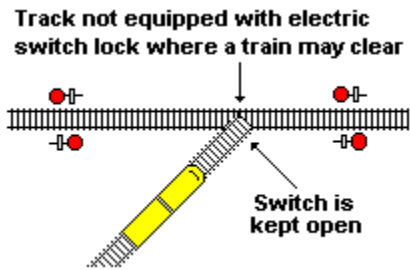

[Diagram D]

### Rule Updated Date

April 7, 2010

[^Top](#)

## 10.3: Track and Time

The control operator may authorize a train to occupy a track or tracks within specified limits for a certain time period. Authority must include track designation, track limits, and either a time limit or the words 'until released'. The train may use the track in either direction within the specified limits according to signal indication until the limits are verbally released.

Limits designated by a switch extend only to the signal governing movement over the switch unless otherwise designated.

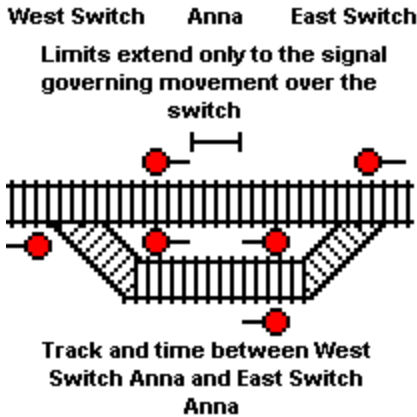

[Diagram A.]^^^

**Track and time does not authorize trains to occupy the track(s) within interlocking limits.**

### A. Passing Signal Displaying Stop or Stop and Proceed Indication

Except at interlockings, trains granted track and time:

1. After stopping at a signal displaying a Stop indication, authority must be granted to enter the limits at either end. Authority from the control operator is not required after stopping within the limits or when entering the limits at any other location. Train must move at restricted speed.
2. Must observe the requirements for inspection of spring switches.
3. May pass a signal within the limits displaying Stop and Proceed indication without stopping.

### B. Time Limits

Trains must release track and time before the time granted expires. When necessary to modify the expiration time, an employee and the control operator must communicate before time expires to adjust the time granted. If the employee cannot contact the control operator and the time limit expires, authority is extended until the control operator is contacted.

### C. Releasing When Within the Limits

Employees releasing track and time must state:

- Their name or other identification.
- The track and time limits being released, including number, if applicable.

If no other employee has received track and time within the same limits, a train may release track and time to move in a specified direction. Signal indications will then govern the train, if the control operator verbally authorizes the release specifying direction of movement.

### D. Releasing Portion of Limits.

When a crew member informs the control operator that the authority is released between two specific points, the authority is considered void between those points. This track release must begin at the outer limit of the authority.

### Application of the second paragraph:



When the track and time includes "Switch Yes," the limits include that switch and the track between the absolute signals governing movement over the switch.

**Application of the boxed sentence:**

Track and time limits are sometimes issued across an interlocking. Track and time provides authority to be on the main track in CTC on both sides of the interlocking; however, it does not provide authority to occupy the interlocking limits. Interlocking rules apply.

**Rule Updated Date**

May 10, 2022

**System Special Instructions**

Effective Date: May 10, 2022

[^Top](#)

### **10.3.1: Protection of Limits**

Before granting track and time, the control operator must apply blocking or marking devices to the control machine to prevent movement into the limits. The control operator may only grant track and time:

- 1 If the limits are clear.
- 2 If the limits are occupied by a train with track and time or that will receive track and time.
  - 3 For an engine to switch a train standing within the limits. Crew members on the engine must provide protection . against possible movement of the standing train, if necessary.
- or
- 4 After all trains moving within the limits that do not have track and time have passed the location where the track will be . occupied, and the employee has been notified that authority is granted behind such trains.

Blocking or marking devices must not be changed or removed until limits have been released to the control operator.

**Rule Updated Date**

April 7, 2010

[^Top](#)

### **10.3.2: Protection of Machines, Track Cars, or Employees**

Machines, track cars, or employees will receive track and time in the same manner as trains.

Machines, track cars, or employees must be clear of the limits before the employee granted track and time releases the authority.

**Rule Updated Date**

April 7, 2010

[^Top](#)

### **10.3.3: Joint Track and Time**

Before track and time is granted where limits will be jointly occupied, the control operator must issue joint track and time to all trains, machines, track cars or employees within the same limits or that will enter the limits. Trains must move at restricted speed within joint track and time limits.

#### **Rule Updated Date**

April 7, 2010

[^Top](#)

### **10.3.4: Track and Time Acknowledgment**

Track and time authority must be recorded and repeated to the control operator. Acknowledgment must be received before being acted upon.

The employee will repeat the preprinted information and information transmitted by the train dispatcher including what has been entered in the summary, "This authority has (total number) boxes marked: (individual box numbers)."

#### **Rule Updated Date**

April 1, 2015

#### **System Special Instructions**

Effective Date: April 1, 2015

[^Top](#)

## 11.0: RULES APPLICABLE IN ACS, ATC AND ATS TERRITORIES

- [11.1: Establishing Absolute Block](#)
- [11.2: Signal Indications with Absolute Block](#)
- [11.3: Broken or Missing Seals](#)

### 11.1: Establishing Absolute Block

Absolute block may be established in advance of a train. The train dispatcher can establish it verbally or by issuing a track bulletin addressed only to the train affected by stating, "Absolute block is established in advance of your train between \_\_\_\_\_ and \_\_\_\_\_."

#### Rule Updated Date

April 7, 2010

[^Top](#)

### 11.2: Signal Indications with Absolute Block

When absolute block is established in advance of a train, the train must not pass a signal indicating Stop, Stop and Proceed, Restricted Proceed, or Restricting unless verbally authorized by the train dispatcher. However, the train may leave the main track through a switch that is immediately after a signal indicating Stop and Proceed, Restricted Proceed or Restricting.

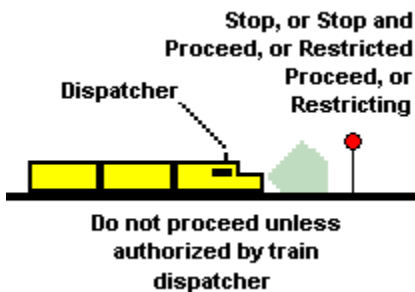

[Diagram A]

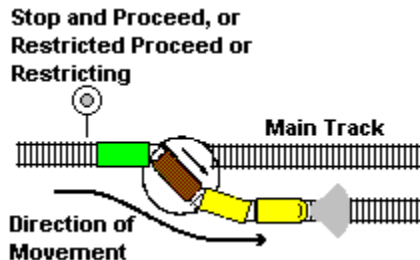

[Diagram B]

When absolute block is established in advance of a train, the train dispatcher must not authorize the train to pass a signal indicating Stop, Stop and Proceed, Restricted Proceed, or Restricting until the block governed by that signal is clear of trains.

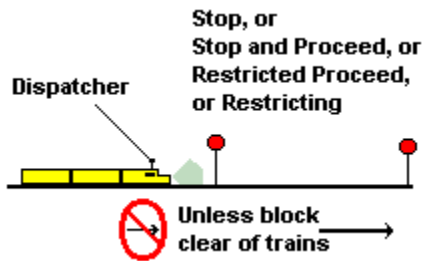

[Diagram C]

If authorized to pass the signal, the train must proceed at restricted speed until it reaches the next governing signal.

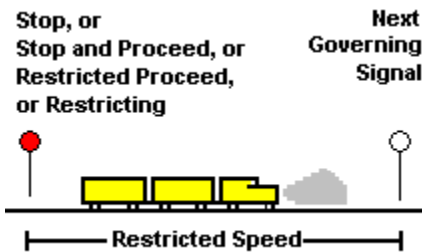

[Diagram D]

#### Rule Updated Date

August 31, 2014

[^Top](#)

### 11.3: Broken or Missing Seals

Do not break the seal on the cutout cock or cut out ACS or ATS devices unless they do not operate properly. Report ACS or ATS failures, interruptions, and removal of or missing seals to the train dispatcher immediately.

#### Rule Updated Date

April 7, 2010

[^Top](#)

## [Union Pacific Rules](#)

### [UPRR - General Code of Operating Rules](#)

## **12.0: RULES APPLICABLE ONLY IN AUTOMATIC TRAIN STOP SYSTEM (ATS) TERRITORY**

- [12.1: Required Equipment](#)
- [12.1.1: ATS Seals and Keys](#)
- [12.2: ATS Device Cut Out, Not Equipped, or Not Working](#)
- [12.3: Unusual Conditions](#)
- [12.3.1: ATS Penalty Brake Application](#)
- [12.3.2: ATS Inoperative](#)
- [12.3.3: Damaged Inductor](#)
- [12.4: ATS Testing](#)
- [12.4.1: Test Inductor Locations](#)
- [12.4.2: No Test Inductors](#)

### **12.1: Required Equipment**

Except as provided in Rule 12.2 (ATS Device Cut Out, Not Equipped, or Not Working), an engine controlling the air brakes of a passenger train within ATS limits must be equipped with an operative ATS device.

#### **Rule Updated Date**

July 11, 2023

#### **System Special Instructions**

Effective Date: July 11, 2023

[^Top](#)

### **12.1.1: ATS Seals and Keys**

When operating in ATS territory, the ATS must be sealed or locked.

#### **Rule Updated Date**

April 7, 2010

[^Top](#)

### **12.2: ATS Device Cut Out, Not Equipped, or Not Working**

Within ATS limits, if the ATS device on an engine controlling the trains air brakes fails or is cut out enroute, or if the engine on a train being detoured is not equipped with a working ATS device, the following will apply:

- The train dispatcher must be notified promptly by radio or telephone.
- The train may proceed according to signal indication, but cannot exceed 40 mph until an absolute block is established in advance of the train.
- If an absolute block is established in advance of the train as provided in Rule 11.1 (Establishing Absolute Block), the train may proceed according to signal indication, but cannot exceed 79 MPH.

**Rule Updated Date**

April 7, 2010

[^Top](#)

## **12.3: Unusual Conditions**

**Rule Updated Date**

April 7, 2010

[^Top](#)

### **12.3.1: ATS Penalty Brake Application**

When two successive ATS penalty brake applications have occurred while passing over inductors at signals displaying Proceed, engineer must acknowledge at each succeeding inductor thereafter, regardless of signal indications and report to the train dispatcher.

**Rule Updated Date**

April 7, 2010

[^Top](#)

### **12.3.2: ATS Inoperative**

The ATS system is considered inoperative when:

- Acknowledging at subsequent inductors at signals when required by Rule 12.3.1 (ATS Penalty Brake Applications), or at two successive inert inductors, does not prevent penalty stops.
  - The acknowledgment alarm fails to sound or light fails to illuminate when acknowledgment is required at an inductor at a wayside signal indicating other than Proceed.
  - Brakes do not apply upon failure to acknowledge a signal indicating other than Proceed.
- OR**
- Absence of, or damage to, an ATS receiver is noted.

**Rule Updated Date**

April 7, 2010

[^Top](#)

**12.3.3: Damaged Inductor**

Employees noting the absence of or damage to a wayside inductor in approach to a signal must notify the train dispatcher. The train dispatcher must immediately call the signal maintainer who must cause the signal to display its most restrictive indication until inductor is replaced or repaired.

**Rule Updated Date**

April 7, 2010

[^Top](#)

**12.4: ATS Testing****Rule Updated Date**

April 7, 2010

[^Top](#)

**12.4.1: Test Inductor Locations**

1. Move engine at 3 MPH or more over first inductor while holding the acknowledging device in full position (not over 15 seconds) to determine that brake application does not occur.
2. Move engine at 3 MPH or more over second inductor and do not acknowledge, a brake application should occur. Operate reset device to full position and release brakes.
3. Report as prescribed in Rule 17.4.1.

**Rule Updated Date**

April 7, 2010

[^Top](#)

**12.4.2: No Test Inductors**

At locations where there are no test inductors:

1. Pass a test bar under the ATS receiver while holding the acknowledging device in full position (not over 15 seconds) to determine that brake application does not occur.

2. Pass a test bar under the ATS receiver and do not acknowledge. A brake application should occur. Operate reset device to full position and release brakes.
3. Report as prescribed in Rule 17.4.1.

**Rule Updated Date**

April 7, 2010

[^Top](#)



## [Union Pacific Rules](#)

### UPRR - General Code of Operating Rules

## **13.0: RULES APPLICABLE ONLY IN AUTOMATIC CAB SIGNAL SYSTEM (ACS) TERRITORY**

- [13.1: General Information](#)
- [13.1.1: Observance of Signals](#)
- [13.1.2: Conforming with Block Signals](#)
- [13.1.3: Does Not Indicate Conditions Ahead](#)
- [13.1.4: Cab Signals Cut In and Out](#)
- [13.1.5: Departure Test](#)
- [13.2: Normal Operation](#)
- [13.2.1: Restrictive to More Favorable](#)
- [13.2.2: Favorable to More Restrictive](#)
- [13.2.3: Elimination of Audible Indicator](#)
- [13.3: Unusual Conditions](#)
- [13.3.1: Cab Signal and Block Signal Do Not Agree](#)
- [13.3.2: Inoperative Cab Signal Device](#)
- [13.3.3: Movement with an Inoperative Cab Signal Device](#)

### **13.1: General Information**

#### **Rule Updated Date**

April 7, 2010

[^Top](#)

#### **13.1.1: Observance of Signals**

The Automatic Cab Signal (ACS) system is used in addition to block signals to govern the use of blocks. However, employees must continue to observe rules that govern the use of block signals as well as other rules, except as outlined in Rules 13.2.1 (Restrictive to More Favorable) and 13.2.2 (Favorable to More Restrictive).

#### **Rule Updated Date**

April 7, 2010

[^Top](#)

#### **13.1.2: Conforming with Block Signals**

The cab signal and block signal systems are interconnected so that the cab signal agrees with the block signal indication within 8 seconds after the engine passes the block signal that governs entrance into a block.

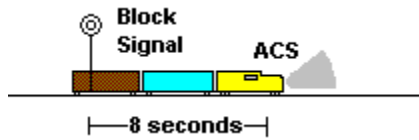

[Diagram A]

### Exception

The ACS system is to be considered inoperative through turnouts and crossovers. Block signal indications and speeds specified in the special instructions for each turnout govern movements through turnouts and crossovers.

### Rule Updated Date

April 7, 2010

[^Top](#)

## 13.1.3: Does Not Indicate Conditions Ahead

Cab signals will not indicate conditions ahead when the engine is:

- Moving against the current of traffic.
  - Shoving cars.
- OR**
- Moving backward and not equipped for backward operation.

### Rule Updated Date

April 7, 2010

[^Top](#)

## 13.1.4: Cab Signals Cut In and Out

The cab signal on the lead unit must be cut in before entering and while operating within ACS territory and placed in partial cutout after leaving ACS territory.

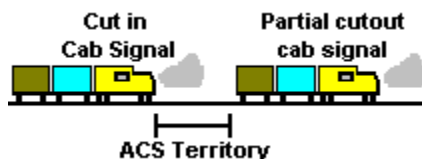

[Diagram A]

The cab signal must be placed in partial cutout on all trailing units in ACS territory.

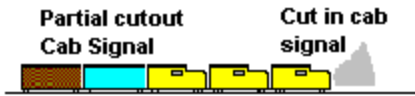

[Diagram B]

Before taking charge of an engine in or approaching ACS territory, the engineer must know that the cab signal devices are cut in and operative and that the ACS cutout is properly sealed. If the device was cutout or seal is missing upon taking charge of a locomotive, the ACS equipment must be re-tested. If device was previously tested and fails to function properly upon entering, or while operating in ACS territory, the train dispatcher must be notified and the train must be operated under an absolute block. If the device was not tested previously, the engineer must make a departure test prior to entering ACS territory.

**Do not cut out cab signal devices while the train is in ACS territory, unless authorized to do so.**

#### **Rule Updated Date**

April 7, 2010

[^Top](#)

### **13.1.5: Departure Test**

Rule has been deleted.

#### **Rule Updated Date**

July 11, 2023

#### **System Special Instructions**

Effective Date: July 11, 2023

[^Top](#)

### **13.2: Normal Operation**

#### **Rule Updated Date**

April 7, 2010

[^Top](#)

#### **13.2.1: Restrictive to More Favorable**

Cab signal indications do not supersede the indication displayed on block and interlocking signals. However, when a cab signal changes to a more favorable indication after having passed the block or interlocking signal, the train may immediately comply with the indication.

## Rule Updated Date

April 7, 2010

[^Top](#)

### 13.2.2: Favorable to More Restrictive

When a cab signal changes to a more restrictive indication, the engineer must comply promptly with the indication received.

#### Acknowledging Restrictive Indication

When a cab signal changes to a more restrictive indication, the engineer must acknowledge the change with the acknowledging device. On engines not equipped with the Coded Cab Signal-Safety Control (CCS-SC) System, another member of the crew must immediately find out from the engineer why the warning whistle sounded longer than 6 seconds. When conditions require, the crew member must stop the train immediately.

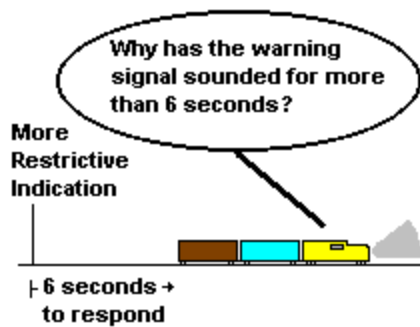

[Diagram A]

On engines equipped with CCS-SC, the engineer must acknowledge the change within 6 seconds of receiving it to avoid a penalty brake application.

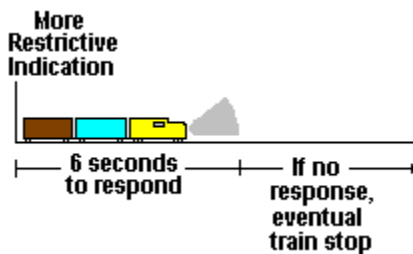

[Diagram B]

#### Penalty Brake Application Occurs

On engines equipped with CCS-SC, if the engineer does not acknowledge the more restrictive indication, a full service penalty brake application will occur automatically within 6 to 8 seconds. When this occurs, the engineer must do the following:

- Place the automatic brake valve handle in suppression position and leave it there until the train stops.
- Place the throttle in idle position.
- Acknowledge the signal change with the acknowledging device.
- After the train has stopped and the P.C. light goes out, place the automatic brake valve handle in release position.

**Rule Updated Date**

April 7, 2010

[^Top](#)

**13.2.3: Elimination of Audible Indicator**

To keep the audible indicator from sounding while the train is stopped in a cab signal test loop, place the reverser handle in either the neutral or reverse position. This will change the cab signal to its most restrictive aspect. After acknowledging the signal change, no more signal changes will be received.

Place the reverser handle in the forward position to automatically restore the equipment to normal operation.

Since the reverser handle in trailing units is in neutral position, the audible indicator is automatically silenced on trailing units.

**Rule Updated Date**

April 7, 2010

[^Top](#)

**13.3: Unusual Conditions****Rule Updated Date**

April 7, 2010

[^Top](#)

**13.3.1: Cab Signal and Block Signal Do Not Agree**

If the cab signal does not display the proper ACS aspect shown in the Block and Interlocking Signal Rules:

- The most restrictive block or cab signal indication must be complied with. A crew member must promptly notify the train dispatcher of the location, signal number, and track where the signals did not agree.
- At control point locations with only an absolute signal(s), when authorized by the train dispatcher to pass the Stop indication, the cab signal may change to a more favorable indication at the signal. The train may comply with the cab signal indication. This is normal due to track circuitry and would not be considered an improper display of the cab signal.

**Exception:** When the train dispatcher's instructions require the train to proceed at Restricted Speed, the train must comply with the train dispatcher's instructions regardless of cab signal indication.

**Rule Updated Date**

April 7, 2010

[^Top](#)

### 13.3.2: Inoperative Cab Signal Device

The ACS system is to be considered inoperative when:

- The audible indicator does not sound when the cab signal changes to a more restrictive indication.
  - The audible indicator continues to sound when the cab signal change is acknowledged.
  - The cab signal does not conform at two consecutive block or interlocking signal locations.
- OR**
- Any part of the cab signal device is damaged.

#### Known in Advance

When it is known in advance that the ACS system is inoperative in a specific area, crew members will be notified with a track bulletin.

#### Rule Updated Date

April 7, 2010

[^Top](#)

### 13.3.3: Movement with an Inoperative Cab Signal Device

When it is determined the cab signal device is inoperative, the train may proceed according to block signal indications. However, the train must not exceed 40 MPH until it reaches a point where a crew member can report the defect to the train dispatcher.

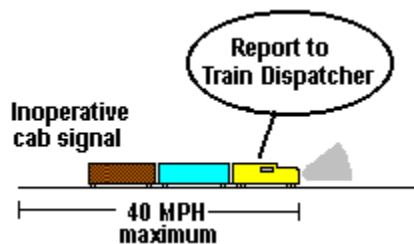

[Diagram A]

The train dispatcher will:

- Instruct the crew to cut out the cab signal device.
- Establish an absolute block in advance of the train.
- Instruct the crew to position the acknowledging lever in the Partial Cutout position (C/O) when cab signal is inoperative due to a power outage.

When the cab signal device has been cut out, the train must:

- Proceed according to block signal indications, not exceeding 79 MPH.
- Comply with Rule 11.2 (Signal Indications with Absolute Block).

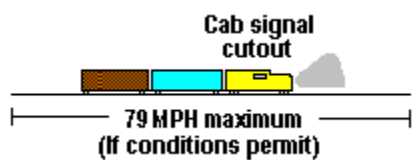

[Diagram B]

When it is determined the cab signal device is inoperative due to a power outage, a crew member will position the acknowledging lever in the Partial Cutout position.

#### **Rule Updated Date**

April 7, 2010

[^Top](#)

[Union Pacific Rules](#)

UPRR - General Code of Operating Rules

**14.0: RULES APPLICABLE ONLY WITHIN TRACK WARRANT CONTROL (TWC) LIMITS**

- [14.0: RULES APPLICABLE ONLY WITHIN TRACK WARRANT CONTROL \(TWC\) LIMITS](#)
- [14.1: Authority to Enter TWC Limits](#)
- [14.2: Designated Limits](#)
- [14.3: Operating with Track Warrants](#)
- [14.3.1: Leaving the Main Track](#)
- [14.4: Occupying Same Track Warrant Limits](#)
- [14.4.1: Radio Blocking](#)
- [14.5: Protecting Men or Equipment](#)
- [14.6: Movement Against the Current of Traffic](#)
- [14.7: Reporting Clear of Limits](#)
- [14.8: Track Warrant Requests](#)
- [14.9: Copying Track Warrants](#)
- [14.9.1: Duplicating Track Warrants](#)
- [14.10: Track Warrant in Effect](#)
- [14.11: Changing Track Warrants](#)
- [14.12: Not Used](#)
- [14.13: Mechanical Transmission of Track Warrants](#)

**14.0: RULES APPLICABLE ONLY WITHIN TRACK WARRANT CONTROL (TWC) LIMITS**



TRACK AUTHORITY FORM – TE&Y

FORM 20705

(circle one)

Track Warrant

Track & Time

Track Permit

Number: \_\_\_\_\_

Date: \_\_\_\_\_

To: \_\_\_\_\_

At: \_\_\_\_\_

1.  Track warrant \_\_\_\_\_ is void
2.  Not in effect until after the arrival of \_\_\_\_\_, \_\_\_\_\_, \_\_\_\_\_ at \_\_\_\_\_
3.  Proceed from \_\_\_\_\_ to \_\_\_\_\_ on \_\_\_\_\_ track \_\_\_\_\_ Subdivision
4.  Hold Main Track at last named point
5.  Clear Main Track at last named point
6.  Do not foul limits ahead of \_\_\_\_\_, \_\_\_\_\_, \_\_\_\_\_
7.  Work between \_\_\_\_\_ and \_\_\_\_\_ on \_\_\_\_\_ track \_\_\_\_\_ Subdivision
8.  Authority granted between CP \_\_\_\_\_ on \_\_\_\_\_ (track) Switch Yes / No  
and CP \_\_\_\_\_ on \_\_\_\_\_ (track) Switch Yes / No  
Joint \_\_\_\_\_ Blocked until \_\_\_\_\_ Extended to \_\_\_\_\_

9.  Limits jointly occupied between \_\_\_\_\_ and \_\_\_\_\_

(NOTE: Trains must move at restricted speed within joint authority limits)

10.  Joint with \_\_\_\_\_ between \_\_\_\_\_ and \_\_\_\_\_  
Joint with \_\_\_\_\_ between \_\_\_\_\_ and \_\_\_\_\_  
Joint with \_\_\_\_\_ between \_\_\_\_\_ and \_\_\_\_\_

11.

From	To	Speed	Track	Flags At

12.  Comply with Procedure \_\_\_\_\_ at/between MP \_\_\_\_\_ and MP \_\_\_\_\_  
Comply with Procedure \_\_\_\_\_ at/between MP \_\_\_\_\_ and MP \_\_\_\_\_  
The \_\_\_ switch at \_\_\_\_\_ is lined for siding  
The \_\_\_ switch at \_\_\_\_\_ is lined for siding  
Leave the \_\_\_ switch at \_\_\_\_\_ lined for siding  
Leave the \_\_\_ switch at \_\_\_\_\_ lined for siding

\_\_\_\_\_  
\_\_\_\_\_  
\_\_\_\_\_

Box(es) marked: \_\_\_\_\_

OK at \_\_\_\_\_ Dispatcher \_\_\_\_\_ Relayed to \_\_\_\_\_ Copied by \_\_\_\_\_

Clear of \_\_\_\_\_ at \_\_\_\_\_ Disp \_\_\_\_\_ by \_\_\_\_\_

Clear of \_\_\_\_\_ at \_\_\_\_\_ Disp \_\_\_\_\_ by \_\_\_\_\_

Clear of \_\_\_\_\_ at \_\_\_\_\_ Disp \_\_\_\_\_ by \_\_\_\_\_

Limits reported clear at \_\_\_\_\_ by \_\_\_\_\_

### Rule Updated Date

May 10, 2022

### System Special Instructions

Effective Date: May 10, 2022

[^Top](#)

## 14.1: Authority to Enter TWC Limits

Where designated by the timetable, a track warrant will authorize main track use under the direction of the train dispatcher or as prescribed by Rule 6.13 (Yard Limits) or 6.14 (Restricted Limits). Track warrant instructions must be followed where yard limits or restricted limits are in effect.

### Rule Updated Date

April 7, 2010

[^Top](#)

## 14.2: Designated Limits

Track warrant limits must be designated by specifying track, where required, and specific locations such as switches, mile posts, or railroad identifiable points. However, station names may be used as follows:

### A. First Named Point

When a station name designates the first named point, authority extends from and includes the last siding switch. Authority extends from the station sign if no siding exists.

### B. Last Named Point

When a station name designates the last named point, authority extends to and includes the first siding switch. Authority extends to the station sign if no siding exists.

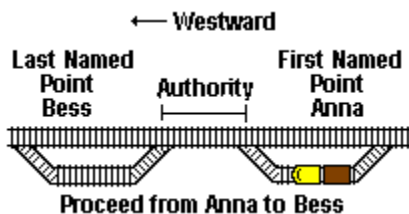

[Diagram A]

At the last named point, authority extends to but does not include the last siding switch when the track warrant states, "Hold main track at last named point."

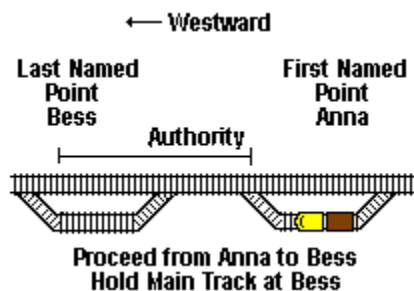

[Diagram B]

### Rule Updated Date

April 7, 2010

[^Top](#)

## 14.3: Operating with Track Warrants

A track warrant authorizes a train or engine to occupy the main track within designated limits. However, the train or engine must not foul a switch at either end of the limits where an opposing train may use the same switch to clear the main track.

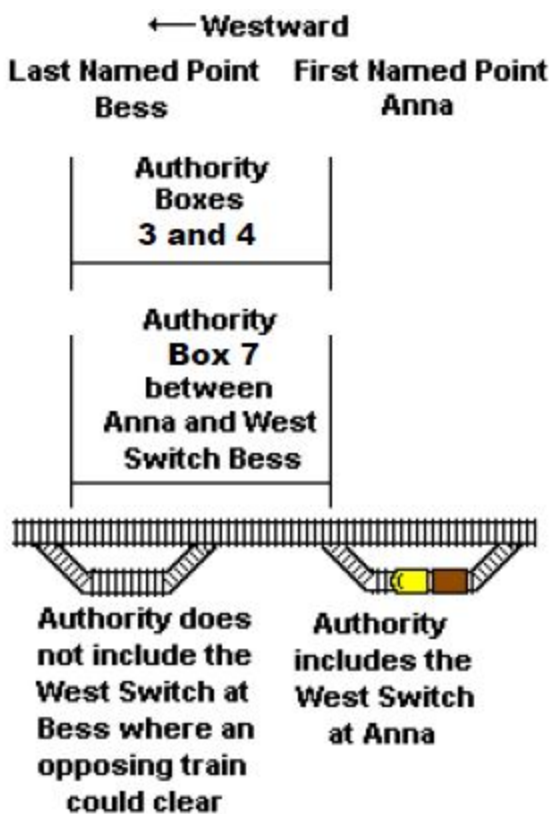

[Diagram A]^^^

The train or engine must move as follows:

1. Proceed from one point to another in the direction the track warrant specifies. When a crew member informs the train dispatcher that the entire train has passed a specific point, track warrant authority is considered void up to that point.  
or
2. If authorized to 'WORK BETWEEN' two specific points, the train or engine may move in either direction between those points. When a crew member informs the train dispatcher that the authority is released between two specific points, the authority is considered void between those points. This track release must begin at the outer limit of the authority.

#### **Rule Updated Date**

April 1, 2015

#### **System Special Instructions**

Effective Date: April 1, 2015

[^Top](#)

### **14.3.1: Leaving the Main Track**

A train authorized to proceed in one direction must inform the train dispatcher when it leaves the main track before reaching the last named point, unless a crew member is left to prevent a following movement from passing.

Unless otherwise authorized by the train dispatcher, trains and engines occupying sidings not listed on track warrant must not exceed 10 MPH in the siding.

#### **Rule Updated Date**

October 10, 2017

#### **System Special Instructions**

Effective Date: June 1, 2018

[^Top](#)

### **14.4: Occupying Same Track Warrant Limits**

A track warrant must not be issued to a train within the same or overlapping limits with another train unless:

1. In signaled territory, all trains are authorized to proceed in the same direction.
2. In non-signaled territory, all trains are authorized to proceed in the same direction and are instructed to move at restricted speed.
3. Two or more trains are authorized to "WORK BETWEEN" two specific points at restricted speed within the overlapping limits.

4. Trains are authorized to proceed through the limits of another train authorized to "WORK BETWEEN" two specific points, and track warrants instruct all trains to move at restricted speed within the overlapping limits. When station name (s) designate the overlapping limits, refer to Rule 14.2 (Designated Limits) for limits where trains are required to move at restricted speed.
5. Radio Blocking is authorized as outlined by Rule 14.4.1 (Radio Blocking).  
or
6. Track Warrant contains conditional authority instruction "NOT IN EFFECT UNTIL AFTER THE ARRIVAL OF".

Where track warrant authority includes yard limits or restricted limits, the terms of Rule 6.13 (Yard Limits) or Rule 6.14 (Restricted Limits) apply, but track warrant instructions must be followed.

### **Rule Updated Date**

April 19, 2022

### **System Special Instructions**

Effective Date: May 10, 2022

[^Top](#)

## **14.4.1: Radio Blocking**

Where designated by special instructions, in non-sigaled territory, more than one train may be authorized to proceed in the same direction within the same or overlapping limits, provided the following train:

- Is notified on the track authority of the identity of the preceding train.
- Does not occupy the limits ahead of the preceding train.
- Notifies the crew of the preceding train that radio blocking has been authorized stating the limits.
- Is notified by the preceding train that the entire train has passed a specific location. Location specified must not be beyond limits indicated. The following words must be used: "(Train) clear of (location)".
- Does not proceed beyond the last location the preceding train has reported to have passed.

All instructions between the trains must be written, repeated, and acknowledged with "THAT IS CORRECT" before being acted on. These written instructions between the trains must be retained until the end of tour of duty.

Notify the train dispatcher if communication cannot be established between the two trains. If necessary, radio blocking information may be relayed only by the train dispatcher.

The last named point of the following train's authority must not extend beyond the last named point of the preceding train's authority.

In the application of Rule 6.4 (Reverse Movements) and Rule 6.6 (Back Up Movements), the movement must not go beyond the last specific location reported to the following train.

<b>Written Instructions Between Trains</b>
--

(Suggested Form)
------------------

(Following Train ID) is authorized Radio Blocking from \_\_\_\_\_ to \_\_\_\_\_ behind (Preceding Train ID).

	<i>LOCATION</i>		<i>TIME</i>		<i>CREW MEMBER</i>
<i>(Preceding Train ID) clear of</i>	_____	<i>at</i>	_____	<i>reported by</i>	_____
	_____	<i>at</i>	_____	<i>reported by</i>	_____
	_____	<i>at</i>	_____	<i>reported by</i>	_____
	_____	<i>at</i>	_____	<i>reported by</i>	_____
	_____	<i>at</i>	_____	<i>reported by</i>	_____

**Rule Updated Date**

April 1, 2015

[^Top](#)

**14.5: Protecting Men or Equipment**

Men or equipment may receive a track warrant in the same manner as trains to occupy or perform maintenance on the main track without other protection.

A track warrant must not be issued to protect men or equipment within the same or overlapping limits with a train unless:

1. All trains are authorized to proceed in one direction only, and the track warrant specifies that men or equipment do not occupy limits ahead of these trains.  
or
2. All trains authorized are notified of the men or equipment and have been instructed by track warrants to move at restricted speed within overlapping limits. When station name(s) designate the overlapping limits, refer to Rule 14.2 (Designated Limits) for limits where trains are required to move at restricted speed. Also, a track warrant must inform the employee in charge of men or equipment about the trains. If the track is not safe for trains to move at restricted speed, the employee must protect the track with red flags according to Rule 5.4.7 (Display of Red Flag).

**Rule Updated Date**

April 1, 2015

[^Top](#)

**14.6: Movement Against the Current of Traffic**

When a track warrant authorizes a train to move against the current of traffic, the train must use only the track designated within the specified limits. This train must not allow a train following on the same track to pass, unless the train dispatcher instructs it to pass.

**Application:**

This rule does not apply on UPRR unless designated in the timetable.

## **Rule Updated Date**

April 1, 2015

## **System Special Instructions**

Effective Date: April 1, 2015

[^Top](#)

## **14.7: Reporting Clear of Limits**

Before reporting clear of limits, or having passed a specific location, or utilizing the "Release This Authority" function on the on-board locomotive system, confirm with the dispatcher that the conductor and engineer have discussed their location and are in agreement with limits or warrant being released. Communication must include the track warrant number when releasing track warrants.

A train without a crew member on the rear and operating in non-signaled or double track territory may report clear of the limits, report having passed a specific location, or release the track between two specific locations only when it is known the train is complete. This must be determined by one of the following ways:

1. The rear of the train has a rear-end telemetry device, and air pressure on the head-end device indicates brake pipe continuity.
2. An employee verifies the marker is on the rear of the train.
3. An employee can observe the rear car of the train on which the marker is placed.
4. The train is stopped, and an inspection verifies that the marker is on the rear car of the train.
5. A trackside warning detector transmits an axle count for the train, and the axle count duplicates the axle count transmitted by the previous trackside warning detector.

In non-signaled territory comply with the requirements outlined in Rule 8.3 (Main Track Switches) and advise the train dispatcher:

- All main track switches operated have been restored and locked in normal position.
- Crew members have completed the job briefing.
- Report form is properly initialed.

When a hand-operated switch is used to clear the main track, except where Rule 6.13 (Yard Limits) or Rule 6.14 (Restricted Limits) are in effect, advise the train dispatcher of the position of the switch and that the switch is locked when reporting clear of track warrant limits. Train dispatcher shall repeat the reported switch position and employee releasing the limits shall confirm to the train dispatcher this information is correct.

### **Application**

Crew members are responsible to ascertain and agree on the exact location entire train has passed before reporting past a specific location or clearing track warrant limits.

## **"Roll-up"**

When the train dispatcher requests a train's location to shorten up or "Roll-up" an active track warrant the following communication will apply:

**Train dispatcher:** "I need to roll-up track warrant (number). What will protect the rear of your train, over?"

When reporting past a specific location:

- Crew members will job brief and agree on train's location and location entire train is past.
- When using a milepost location, communication with the train dispatcher will include a whole milepost number (not tenths) the entire train is past.
- When using railroad identifiable points that include a direction, such as a siding switch, state and spell direction i.e. "North (N O R T H) siding switch at Dora".

**Crew member:** "Milepost (number) covers the rear of our train, dispatcher. (Position and Name) ready to copy, over

**After initial communication the train dispatcher will initiate "Roll-up":**

**Sample radio transmissions:**

**Train Dispatcher:** "Track Warrant #46-55, UP 2467 is clear of MP 362, over."

**Crew member:** "Track Warrant #46-55, UP 2467 is clear of MP 362, over."

**Train Dispatcher:** "That is correct at 0817, dispatcher BAF, copied by Smith, over."

**Crew member:** "Correct at 0817, dispatcher BAF, Smith, over."

**Train Dispatcher:** "That's correct, Dispatcher Out."

**Rule Updated Date**

May 10, 2022

**System Special Instructions**

Effective Date: May 10, 2022

[^Top](#)

## **14.8: Track Warrant Requests**

An employee who requests a track warrant must inform the train dispatcher what movements will be made and, when necessary, which tracks will be used and how much time is required.

**Rule Updated Date**

April 7, 2010

[^Top](#)



## 14.9: Copying Track Warrants

Employee will copy Track Warrants using the format outlined in the operating rules. All crew members must each have a paper copy of the track warrant issued to the train, and each crew member must read and understand it. The copy must show the date.

Track Warrants may be transmitted by the dispatcher and received by the PTC on-board system while in the "DISENGAGED" state.

Before acting upon a transmitted authority, the crew must verify the authority number, designated limits, and any conditions of authority with the train dispatcher.

The following must occur when transmitted verbally:

### A. Transmitting Track Warrants

1. The train dispatcher will transmit the track warrant. The train dispatcher will not transmit the summary.
2. An employee will enter all of the information transmitted by the train dispatcher. The employee will then check the information copied to ensure all items are correct and enter in the summary the total number of boxes marked and individual box numbers.
3. The employee will repeat the preprinted and information transmitted by the train dispatcher including what has been entered in the summary, "This track warrant has (total number) boxes marked: (individual box numbers)."
4. The train dispatcher will check the repeat and summary, and if all information including the summary is correct; will say "OK" and give the time and his/her initials.

The employee will enter the OK time and the train dispatcher's initials on the track warrant and repeat them to the train dispatcher.

### B. In Effect

- 1 The track warrant is not in effect until the "OK" time is shown on it.
  - When received by the PTC on-board system, the "OK" time will be given when the authority is issued.
- 2 Authorities that restrict a previously issued authority must not be transmitted until the engineer has confirmed the change to authority can be complied with.

Employees may relay track warrants.

### Rule Updated Date

May 10, 2022

### System Special Instructions

Effective Date: May 10, 2022

[^Top](#)

### **14.9.1: Duplicating Track Warrants**

Employees who reproduce track warrants with a duplicating machine do not need to repeat them to the train dispatcher.

Duplicated track warrants must not be delivered or used until they are checked and verified as:

- Legible
- Duplicated in their entirety.

#### **Rule Updated Date**

April 7, 2010

[^Top](#)

### **14.10: Track Warrant in Effect**

A track warrant is in effect until a crew member reports the train has cleared the limits, or the track warrant is made void. The crew member must inform the train dispatcher when the train has cleared the limits.

Employees reporting clear of track warrant limits must state:

- Their name or other identification.
- Track warrant number being released.
- Limits being released.

#### **Time Limit Shown**

If the track warrant shows a time limit, the train must clear the limits by the time specified, unless another track warrant is obtained. If an employee cannot contact the train dispatcher and the time limit expires, authority is extended until the train dispatcher is contacted.

#### **Rule Updated Date**

April 7, 2010

[^Top](#)

### **14.11: Changing Track Warrants**

Employees must not add to or alter the track warrant in any manner, except as specified by Rule 15.1.1 (Changing Address of Track Warrants or Track Bulletins).

When the limits or instructions of a track warrant must be changed, a new track warrant must be issued voiding the track warrant(s) to be changed.

**Note:** This does not prohibit additions or changes authorized by the rules (e.g. Rule 14.7).

**Rule Updated Date**

April 1, 2015

**System Special Instructions**

Effective Date: April 1, 2015

[^Top](#)

**14.12: Not Used**

**Rule Updated Date**

April 7, 2010

[^Top](#)

**14.13: Mechanical Transmission of Track Warrants**

Repetition is not required when track warrants are transmitted mechanically. The "OK" time will be given when the track warrant is issued.

Track warrants that restrict the authority or movement of a train must not be transmitted mechanically, unless the train being restricted will not leave the point without receiving the track warrant.

Crew members must verify the designated limits and any conditions of track warrants that convey authority with the train dispatcher before initiating movement on main track.

**Rule Updated Date**

May 10, 2022

**System Special Instructions**

Effective Date: May 10, 2022

[^Top](#)

## [Union Pacific Rules](#)

### UPRR - General Code of Operating Rules

## **15.0: TRACK BULLETIN RULES**

- [15.0: TRACK BULLETIN RULES - TRACK CONDITION SUMMARY](#)
- [15.1: Track Bulletins](#)
- [15.1.1: Changing Address of Track Warrants, Track Bulletins, or Track Condition Summary](#)
- [15.2: Protection by Track Bulletin Form B](#)
- [15.2.1: Reserved](#)
- [15.2.2: Protection of Non-Railroad Contractors](#)
- [15.3: Authorizing Movement Against the Current of Traffic](#)
- [15.4: Protection when Tracks Removed from Service](#)
- [15.5: Protection When Tracks Blocked With Equipment](#)
- [15.6: Change of a General Order, Special Instruction, or Rule](#)
- [15.7: Copying Track Bulletins](#)
- [15.8: Duplicating Track Bulletins](#)
- [15.9: Mechanical Transmission of Track Bulletins](#)
- [15.10: Retaining Track Bulletins](#)
- [15.11: Not Used](#)
- [15.12: Relief of Crew Member\(s\) During Trip](#)
- [15.12.1: Relief of Crew at Crew Change Location](#)
- [15.13: Voiding Track Bulletins](#)
- [15.13.1: Verbally Raising a Speed Restriction](#)
- [15.14: Delivering Track Bulletins](#)

## **15.0: TRACK BULLETIN RULES - TRACK CONDITION SUMMARY**

Form B's will have asterisks before and after the bulletin. When flags are displayed in less than the prescribed distance, the milepost and direction will be shown. If flags are not displayed "NOT" will be shown.

**Example: Track Condition Summary**

NO: (Track Warrant)      TO: (Train ID)

Subdivision (000)

42683(2) 42554(3) 42276(2) 42034

LINE NO.	LIMITS		MPH	TRACK(S) AFFECTED	FLAG	FLAG AT MP	FOR DIR	FROM DATE	TIME	UNTIL DATE	TIME
----------	--------	--	-----	-------------------	------	------------	---------	-----------	------	------------	------

FORM A NO. 42683

1.	43.9	44	40	MT 2		43	WWD	04/07/14	1220		
----	------	----	----	------	--	----	-----	----------	------	--	--

2.	46.6	47.1	40	MT 2				04/11/14	1318		
----	------	------	----	------	--	--	--	----------	------	--	--

FORM A NO. 42554

1.	51	51.2	40	MT 2				04/10/14	1102		
----	----	------	----	------	--	--	--	----------	------	--	--

2.	55.5	55.6	40	MT 2				04/10/14	0100		
----	------	------	----	------	--	--	--	----------	------	--	--

LINE NO.	LIMITS		TIME		TRACK(S) AFFECTED	FLAG AT MP	FOR DIR	GANG NO / FOREMAN	
----------	--------	--	------	--	-------------------	------------	---------	-------------------	--

\*\*\*\*\*FORM B NO. 42276\*\*\*\*\*

ON 04/14/14 RULE 15.2 APPLIES WITHIN THE FOLLOWING LIMITS:

1.	113	118	0700	1900	MT 1		112	WWD	4763	GUTZ
----	-----	-----	------	------	------	--	-----	-----	------	------

2.	113	118	0700	1900	MT 2		112	WWD	4763	GUTZ
----	-----	-----	------	------	------	--	-----	-----	------	------

LINE NO.	LIMITS		MPH	TRACK(S) AFFECTED	FLAG	FLAG AT MP	FOR DIR	FROM DATE	TIME	UNTIL DATE	TIME
----------	--------	--	-----	-------------------	------	------------	---------	-----------	------	------------	------

FORM A NO. 42554

3.	114.4	116.3	60	MT 2				04/10/14	1118		
----	-------	-------	----	------	--	--	--	----------	------	--	--

FORM C NO. 42034

Date 04/03/14

1. SIDING AT WILD OUT OF SERVICE SWITCHES ARE SPIKED AND TAGGED

**For Train Movements in the Opposite Direction.**

**Example: Track Condition Summary**

NO: (Track Warrant)      TO: (Train ID)

Subdivision (000)

42276(2)   42554(3)   42683(2)   42034

```

-----
LINE      LIMITS      TIME      TRACK(S)  FLAG  FOR      GANG
NO.  FROM MP TO MP  FROM UNTIL  AFFECTED  AT MP  DIR      NO / FOREMAN
-----

```

\*\*\*\*\*FORM B NO. 42276\*\*\*\*\*

ON 04/14/14 RULE 15.2 APPLIES WITHIN THE FOLLOWING LIMITS:

1. 118 113 0700 1900 MT 1 112 WWD 4763 GUTZ

2. 118 113 0700 1900 MT 2 112 WWD 4763 GUTZ

```

-----
LINE      LIMITS      TRACK(S)  FLAG  FOR      FROM      UNTIL
NO.  FROM MP TO MP  MPH  AFFECTED  FLAG  AT MP  DIR      DATE  TIME  DATE  TIME
-----

```

FORM A NO. 42554

3. 116.3 114.4 60 MT 2 04/10/14 1118

2. 55.6 55.5 40 MT 2 04/10/14 0100

1. 51.2 51 40 MT 2 04/10/14 1102

FORM A NO. 42683

2. 47.1 46.6 40 MT 2 04/11/14 1318

1. 44 43.9 40 MT 2 43 WWD 04/07/14 1220

FORM C NO. 42034

DATE 04/03/14

1. SIDING AT WILD OUT OF SERVICE SWITCHES ARE SPIKED AND TAGGED

Below the last line of data there will be a blank line then the page number. Nothing should be printed below the page number.

OK times and Train Dispatchers initials are not shown.

**Form A and Form B Track Bulletins**

On the subdivision summary page, the track bulletin number for Form A and Form B bulletins will have, in parenthesis, the number of line items for that track bulletin. Because of the sorting by milepost, any particular Form A or Form B bulletin may be split by another Form A or Form B bulletin in the body of the Track Condition Summary.

**Form C Track Bulletins**

Form C track bulletins for a particular subdivision will be listed after the Form A and Form B bulletins for that subdivision with two exceptions.

- Listed first on the Track Condition Summary will be Form C bulletins that apply to the entire system. The subdivision heading will be "System Bulletin All Subdivisions".
- Form C bulletins issued on multiple subdivisions will be listed next. These will only be listed once; the subdivision heading will show all the subdivisions that the bulletin has been issued on.

## Rule Updated Date

May 10, 2019

## System Special Instructions

Effective Date: May 10, 2019

[^Top](#)

## 15.1: Track Bulletins

Example Track Warrant for Bulletins / Track Condition Summary			
NO: <u>(Track Warrant)</u>	FROM: <u>(Location)</u>	TO: <u>(Location)</u>	DATE: 4/25/2014
TO: <u>(Train ID)</u>	<u>(Train Symbol)</u>	AT: <u>(Location)</u>	
ON: <u>Subdivision (000)</u>			
16. (X) 4 TRACK BULLETINS IN EFFECT:	42034	42683	42554 42276
17. (X) OTHER SPECIFIC INSTRUCTIONS:			
THIS WARRANT IS USED TO DELIVER TRACK BULLETINS ONLY AND DOES NOT CONVEY AUTHORITY TO OCCUPY THE MAIN TRACK.			
OK <u>(time)</u> DISPATCHER <u>ABC</u> RELAYED TO:		COPIED BY:	

Track bulletins must not be changed unless specified by Rules 15.1.1 (Changing Address of Track Warrants or Track Bulletins) or Rule 15.13 (Voiding Track Bulletins). The train dispatcher will issue track bulletins as required. Track bulletins will contain information on all conditions that affect safe train or engine movement. Forms other than track bulletin Forms A and B may be used when necessary.

### Receipt and Comparison of Track Bulletins

At their initial station, unless otherwise instructed by the train dispatcher, the conductor and engineer must receive track bulletins affecting their train's movement:

- By a track warrant, unless the track warrant shows 'NONE' or 'NO.'
- or
- In a manner designated by special instructions. All rules that apply to track bulletins also apply.

The conductor and engineer must have copies of all track bulletins and other instructions required. Each crew member must read and understand them.

All crew members are responsible for complying with the requirements of track bulletins and reminding each other of those requirements.

At the initial station, when outbound crew members receive track warrants and track bulletins from inbound crew members, the conductor and engineer must compare the track warrants and track bulletins with each other and with the train dispatcher before

proceeding.

At locations where track warrants listing track bulletins are received by printer or fax, crew members must verify that route description, if printed, covers the intended route of the train and that the track warrant includes the correct train ID and train symbol of the train. If it does not, contact the train dispatcher and determine if the track warrant is valid. Also, crew members must check the date and "OK" time on the track warrant and if the track warrant is over 4 hours old, contact the train dispatcher and determine if additional track bulletins are needed.

**Note:** After receiving track warrant, if a crew is assigned to operate a train with a train symbol different than the one listed on the track warrant, the above applies.

**Application:**

Having a copy of the '**Track Condition Summary**' meets the requirement of having a copy of the bulletins listed.

**Rule Updated Date**

May 10, 2022

**System Special Instructions**

Effective Date: May 10, 2022

[^Top](#)

### **15.1.1: Changing Address of Track Warrants, Track Bulletins, or Track Condition Summary**

If the address must be changed on a track warrant / track condition summary used to deliver track bulletins only or a track bulletin that does not grant authority according to Rule 15.3 (Authorizing Movement Against the Current of Traffic), the train dispatcher may verbally change the track warrant / track condition summary number, train symbol, engine identification, direction, or date. However, crews performing yard or hostling service, using the main track at a yard or terminal, may change the engine number or train symbol on track warrants or track bulletins received from the train dispatcher without communicating with the train dispatcher.

**Rule Updated Date**

June 8, 2020

**System Special Instructions**

Effective Date: May 5, 2021

[^Top](#)

### **15.2: Protection by Track Bulletin Form B**



Display track flags as specified in Rule 5.4.3 (Display of Yellow-Red Flag) and Rule 5.4.7 (Display of Red Flag).

A train must not enter the limits unless instructed by the employee in charge. A train within the limits at the time the track bulletin Form B takes effect must not make further movement until instructed by the employee in charge.

A crew member must attempt to contact the employee in charge sufficiently in advance to avoid delay, giving the train's location and track being used. When possible, attempt must be made at least 2 miles in advance of the limits. The crew member must inform the employee in charge if there are any excessive dimension loads in the train. The employee in charge will use the following format to establish communication with the train:

Foreman (name and/or gang number) using Track Bulletin No.\_\_\_\_ (specifying line number when necessary) between MP\_\_\_\_ and MP\_\_\_\_ (specifying subdivision when necessary).

Trains within the limits, unless otherwise restricted, must move at the speed(s) specified by the employee in charge as stated in Item A (Instructions).

### **A. Instructions**

After communication with the train has been established, the employee in charge will use the following format to grant a train permission to proceed through the Form B limits:

- (Train ID) may pass the red flag at MP\_\_\_\_ and proceed at (one of the following), (specifying track when necessary):
  - "Maximum Authorized Speed"
  - "Restricted Speed"
  - A speed specified by the employee in charge

Two additional speeds may be given to restrict a train's movement through a portion of the limits, by adding the following:

- Do not exceed \_\_\_\_MPH between/at MP\_\_\_\_ and MP\_\_\_\_ (or other location).

To require a train to stop at a designated location within the limits, add the following:

- Stop at MP\_\_\_\_ (or other location) until additional instructions are received.

When men or equipment foul adjacent track(s), add the following:

- Men or equipment fouling (specify track).

### **B. Repeat Instructions**

A crew member must repeat the above instructions, and the employee giving the instructions must acknowledge them before they can be followed.

Once instructions are received from employee in charge, if the track route changes from previous instructions received, contact employee in charge to determine that original instructions received are valid on new track route before proceeding on the new route. The movement must not change direction without permission from the employee in charge.

**Application:**

When two Form B track bulletins meet at adjoining subdivisions resulting in a continuous Form B restriction with the same employee in charge and the same time limits, the employee in charge may grant permission and give instructions to the train concerning both Form B's at the same time. The communication will begin using the following format:

Foreman (name) using 2 track bulletins. Track Bulletin No. \_\_\_\_ Line No. \_\_\_\_ Subdivision \_\_\_\_ and Track Bulletin No. \_\_\_\_ Line No. \_\_\_\_ Subdivision \_\_\_\_ between MP \_\_\_\_ and MP \_\_\_\_ (outer mileposts).

**Rule Updated Date**

April 1, 2015

**System Special Instructions**

Effective Date: April 1, 2015

[^Top](#)

**15.2.1: Reserved**

Rule is Reserved.

**Rule Updated Date**

May 5, 2021

**System Special Instructions**

Effective Date: May 5, 2021

[^Top](#)

**15.2.2: Protection of Non-Railroad Contractors**

When authorized non-railroad employees or non-railroad contractors are working near a main track or controlled siding, protection will be provided as outlined below.

- When working within 10 feet of the track, protection will be provided by use of a track bulletin, track and time, track permit, track warrant, or other means of protection. Except in California or when work will be performed foul of the track, a Form C track bulletin may be used:

"EFFECTIVE ON (DATE) FROM (TIME) UNTIL (TIME) BETWEEN MP\_\_\_ AND MP\_\_\_  
PROCEED PREPARED TO STOP SHORT OF MENAND EQUIPMENT NOT TO EXCEED  
20 MPH UNLESS INSTRUCTED OTHERWISE BY FOREMAN (NAME)."

Train receiving track bulletin must proceed within the limits prepared to stop short of men and equipment and not exceed 20 MPH until leading wheels have cleared the limits unless instructed otherwise by the employee in charge. Whistle signal 5.8.2 (8) will be sounded.

- When working between 10 and 25 feet of the track, trains will be notified of their presence by issuance of a Form C track bulletin that reads:

"CONTRACTORS ARE WORKING AT LEAST 10 FEET FROM THE TRACK AT THE  
FOLLOWING LOCATION(S): (IDENTIFIED AT MP\_\_\_ OR BETWEEN MP\_\_\_ and  
MP\_\_\_)."

A watchman must ensure workers and equipment remain at least 10 feet from the track.

Railroad employees who observe work being performed within the boundaries of railroad right-of-way without notification as outlined above should report this information to the train dispatcher for further action.

#### **Rule Updated Date**

April 1, 2015

#### **System Special Instructions**

Effective Date: April 1, 2015

[^Top](#)

### **15.3: Authorizing Movement Against the Current of Traffic**

Where Rule 9.14 (Movement with the Current of Traffic) is in effect, a track bulletin may authorize movement against the current of traffic as follows:

1. "(Train) will use \_\_\_\_\_ track against the current of traffic (point) to (point)."

The train must use only the track specified between these points. Opposing trains must not leave the last point until the train arrives. The train dispatcher must not authorize a following train to move against the current of traffic until the previous train has cleared the last point unless movement is made within PTC territory and the following train is utilizing an operative PTC system.

The example may be modified as follows:

"After (opposing train) arrives at (point) (train) will use \_\_\_\_\_ track against the current of traffic (point) to (point)."

The train that will move against the current of traffic must not leave the first point until the opposing train arrives.

Trains directly affected in both directions must receive this track bulletin and must not:

- Clear the main track.
- Allow a following train to pass.  
OR
- Pass a preceding train, unless authorized by the train dispatcher.

2 "(Time) until (time) (date) all trains use \_\_\_\_ track between (point) and (point). All trains must stop before fouling \_\_\_\_ track between these points unless directed to proceed by employee in charge of switches or by train dispatcher."

This bulletin may also contain information on public crossing protection, switches spiked, intermediate flagman, and so forth.

**Following Movement.** A train may not follow another train against the current of traffic until the previous train has cleared the limits, passed a designated location, or passed a flagman located at the next intermediate point unless movement is made within PTC territory and the following train is utilizing an operative PTC system. Flag protection is not required against following trains.

**Flagmen Not Provided.** When flagmen are not provided, the example will be modified by adding:

- "Normal position of switches at (location) will be as last used. Trains and engines must approach these switches prepared to stop and line switches for intended route"

Trains not utilizing an operative PTC system must contact the train dispatcher to receive an absolute block prior to operating against the current of traffic.

Within PTC territory, trains on which the PTC system becomes inoperative while operating against the current of traffic must immediately reduce to restricted speed and contact the train dispatcher to receive an absolute block.

**Flagman Provided.** When flagmen are provided, the example will be modified by adding:

- "Intermediate flagman located at (point). Trains moving against the current of traffic must stop short of flagman unless directed to proceed."

**Extending Time.** Time may be extended by issuing another track bulletin as follows:

- "Track bulletin No. \_\_ is extended until (time)."

This bulletin will be used when one or more tracks will be removed from service, and all trains in both directions must use the remaining track as directed by the train dispatcher or an employee in charge of switches at each end of the designated limits.

The train dispatcher will authorize movement between the designated points and issue the track bulletin and necessary instructions to the employee in charge of switches. This employee may verbally direct movement or use hand signals. Also, the train dispatcher may use a controlled signal indication to authorize movement.

All affected trains must receive a copy of the track bulletin.

**Rule Updated Date**

May 5, 2021

### **System Special Instructions**

Effective Date: May 5, 2021

[^Top](#)

## **15.4: Protection when Tracks Removed from Service**

Before a track is removed from service it must be protected.

A track bulletin may protect tracks removed from service by designating the track and naming the points at each end of the track. Trains must not use this track unless the track bulletin states the name or title of an employee who may authorize use. This person will direct all movements. Movements must be made at restricted speed unless instructed otherwise by the employee in charge. Movements may then proceed as instructed and in accordance with signal indications.

The control operator must grant authority to pass an absolute signal displaying a Stop indication at control points at either end of the out of service track. Except at interlockings, after stopping, movements may pass Stop indications within the out of service track. When required, the train dispatcher must advise crews of alternate routes and switch positions.

### **Rule Updated Date**

April 1, 2015

### **System Special Instructions**

Effective Date: April 1, 2015

[^Top](#)

## **15.5: Protection When Tracks Blocked With Equipment**

Notify the train dispatcher when main tracks, sidings, or other tracks that are normally clear are blocked with equipment and cannot be cleared.

When the main track is blocked, provide protection as specified by Rule 6.20 (Equipment Left on Main Track).

### **Rule Updated Date**

April 7, 2010

[^Top](#)

## **15.6: Change of a General Order, Special Instruction, or Rule**

When authorized by the designated manager, a track bulletin may be used to issue, change, or cancel general orders, special instructions, or rules.

General orders or special instructions cancelled by track bulletins must not be reinstated. The track bulletin must remain in effect until the general order that contains the change is posted.

**Rule Updated Date**

April 7, 2010

[^Top](#)

## **15.7: Copying Track Bulletins**

The conductor and the engineer must each have a copy of the track bulletins issued to their train, and each crew member must read and understand them. The copy must show the date. The following must occur when track bulletins are transmitted verbally:

1. An employee will enter all of the information on the track bulletin.
2. The employee will repeat the information to the train dispatcher.
3. The train dispatcher will check it and, if correct, will say "OK" and give the time and his initials.
4. The employee will enter the "OK" time and the train dispatcher's initials on the track bulletin and repeat them to the train dispatcher.

Employees may relay track bulletins.

**Rule Updated Date**

April 7, 2010

[^Top](#)

## **15.8: Duplicating Track Bulletins**

Employees who reproduce track bulletins with a duplicating machine do not need to repeat them to the train dispatcher.

Duplicated track bulletins must not be delivered or used until they are checked and verified as:

- Legible.
- Duplicated in their entirety.

**Rule Updated Date**

April 7, 2010

[^Top](#)

## **15.9: Mechanical Transmission of Track Bulletins**

Repetition is not required when track bulletins are transmitted mechanically. The "OK" time will be given when the track bulletin is issued.

**Rule Updated Date**

April 7, 2010

[^Top](#)

**15.10: Retaining Track Bulletins**

Employees must keep and comply with track bulletins on all trips during the tour of duty when track bulletins were received.

When directed by the train dispatcher, track bulletins may be retained for use during the next tour of duty. Before initiating movement on the main track on the next tour of duty, a crew member must verify from the train dispatcher that no additional track bulletins are needed.

**Rule Updated Date**

April 7, 2010

[^Top](#)

**15.11: Not Used****Rule Updated Date**

April 7, 2010

[^Top](#)

**15.12: Relief of Crew Member(s) During Trip**

When being relieved before a trip is finished, contact the train dispatcher and comply with instructions concerning the handling of track warrants, track bulletins, and other instructions.

When crew members are called to relieve a train at other than the initial station, crew members must contact the train dispatcher before leaving the initial station and determine if any track warrants, track bulletins, or other instructions must be obtained.

**Comparison of Information**

The relieving crew member(s) must compare:

- Track warrants, track bulletins, instructions, and pertinent information with each other.
- The track warrant for bulletins/Track Conditions Summary number with the train dispatcher. The train dispatcher will verify that the warrant includes all required track bulletins and will provide any additional restrictions required for the route.

**Rule Updated Date**

January 18, 2023

## **System Special Instructions**

Effective Date: July 11, 2023

[^Top](#)

### **15.12.1: Relief of Crew at Crew Change Location**

When making a crew change, relieving crew members must determine from the inbound crew if there are any unforeseen restrictions issued that have not been fulfilled/traversed or tasks in progress (e.g. air test). When not relieved by another crew, the inbound crew must leave this information in writing for the relieving crew and notify the dispatcher of tasks not completed. In addition, at locations where a yardmaster is on duty, the yardmaster must also be notified.

#### **Rule Updated Date**

May 10, 2022

## **System Special Instructions**

Effective Date: May 10, 2022

[^Top](#)

### **15.13: Voiding Track Bulletins**

To void a numbered line on a track bulletin, a part of a track bulletin, or an entire track bulletin, the train dispatcher may do one of the following:

#### **A. Voiding Track Bulletins Verbally**

Void the track bulletin by verbally using one of the following examples:

1. "Line (number) of track bulletin No. reading (quote the line to be voided) is void."
2. "That part of track bulletin No. reading (quote the part to be voided) is void."
3. "Track bulletin No. is void."

Employee must repeat the information to the train dispatcher. If correct, the word "VOID" will be entered to indicate that portion is no longer in effect.

#### **B. Issue Track Bulletin or a Track Warrant to Void a Track Bulletin**

Issue a track bulletin or use the lines designated on Box 12 on a track warrant using one of the following examples:

1. "Line (number) of track bulletin No. \_\_\_ is void."
2. "That part of track bulletin No. \_\_\_ reading (quote the part to be voided) is void."
3. "Track bulletin No. \_\_\_ is void."



Where paper copies are used, employee will keep a copy of the track warrant or track bulletin that made it void and the word "VOID" will be entered to indicate that portion is no longer in effect.

The track bulletin or the part of the track bulletin indicated will no longer be in effect.

**Rule Updated Date**

September 15, 2015

**System Special Instructions**

Effective Date: September 15, 2015

[^Top](#)

**15.13.1: Verbally Raising a Speed Restriction**

The train dispatcher may verbally raise the speed on an existing speed restriction, Rule 2.14 (Mandatory Directive) applies. The train dispatcher must identify the existing speed restriction; e.g., Form A 1234, line 2. After a crew member informs the train dispatcher they have located the speed restriction and are ready to copy, the train dispatcher will use the following format:

(Train ID) Track Bulletin \_\_\_\_\_, Line No MP \_\_\_ to MP \_\_\_, \_\_MPH (adding track if necessary), speed is increased to \_\_\_ MPH.

The employee will draw a line through the existing speed on the track condition summary form, write the new speed adjacent to the old speed, and then repeat the information to the train dispatcher. If the information is correct, the train dispatcher will state "OK", with the time and the train dispatcher's initials, which must be repeated by the employee.

The new speed must not be acted upon until the train dispatcher states "OK", and gives the time and the train dispatcher's initials.

**Rule Updated Date**

April 1, 2015

**System Special Instructions**

Effective Date: April 1, 2015

[^Top](#)

**15.14: Delivering Track Bulletins**

Employees who copy track bulletins for delivery must deliver copies to all those addressed, unless the track bulletin is voided or transferred to a relieving employee. When employees have delivered copies to all addressed, they must keep a copy on file.

**Rule Updated Date**

April 7, 2010

[^Top](#)

## [Union Pacific Rules](#)

### UPRR - General Code of Operating Rules

## **16.0: RULES APPLICABLE ONLY IN DIRECT TRAFFIC CONTROL (DTC) LIMITS**

- [16.0: RULES APPLICABLE ONLY IN DIRECT TRAFFIC CONTROL \(DTC\) LIMITS](#)
- [16.1: Authority to Enter DTC Limits](#)
- [16.1.1: Switches Between DTC Blocks](#)
- [16.2: DTC Authority](#)
- [16.3: Movement in a Specified Direction](#)
- [16.3.1: Leaving the Main Track](#)
- [16.4: Work and Time](#)
- [16.5: Changing DTC Authority](#)
- [16.6: Releasing DTC Authority](#)
- [16.7: Communication Failure](#)

## **16.0: RULES APPLICABLE ONLY IN DIRECT TRAFFIC CONTROL (DTC) LIMITS**

### **Rule Updated Date**

April 20, 2012

[^Top](#)

### **16.1: Authority to Enter DTC Limits**

The timetable will designate DTC limits. A train may enter DTC limits only after receiving authority from the train dispatcher. Men or equipment may be issued DTC authority in the same manner as trains. DTC territory will not include territory where Rule 6.13 (Yard Limits) or Rule 6.14 (Restricted Limits) is in effect.

### **Rule Updated Date**

April 20, 2012

[^Top](#)

### **16.1.1: Switches Between DTC Blocks**

Switches between DTC blocks may be occupied only when authority includes at least one block on each side of the switch; however, men or equipment may be authorized to occupy a switch located between DTC blocks without authority on each side of the switch when the DTC authority includes the name of the switch and the instructions "Switch Yes." DTC authority must not be released until the rear of the movement has completely entered the adjoining block.

#### **Rule Updated Date**

April 20, 2012

[^Top](#)

## **16.2: DTC Authority**

The train dispatcher will issue DTC authority to a crew member on the head end of the train when possible. An employee operating the controls of a moving engine or on-track equipment may not copy DTC authority.

### **A. Recorded in Writing**

When transmitted verbally, the employee who receives or releases DTC authority must record it in writing and include the following:

1. Name of first and last DTC block where authority is issued.
2. Time that work and time expires.
3. Train identity when DTC authority is issued behind a train or radio blocking behind a preceding train is in effect.
4. Time DTC authority is released to the train dispatcher.

DTC authority must not be transferred to a relieving crew, unless authorized to do so by the train dispatcher.

When verbal authority is received from the train dispatcher to leave equipment in a DTC block, the train dispatcher may instruct a crew member to void the DTC authority.

**Employees cannot act upon DTC authority until the train dispatcher says, "That is correct."**

### **B. Multiple Authorities**

Not more than one DTC authority may be issued in the same DTC block except:

1. In ABS territory, as provided by Rule 16.3 (Movement in a Specified Direction), authority may be issued to more than one train in the same direction.
2. As provided by Rule 16.4 (Work and Time).

or

3. Where radio blocking is designated by special instructions, in non-signaled territory, more than one train may be authorized to proceed in the same direction within the same or overlapping limits, provided the following train:

- Is notified on DTC authority of the identity of the preceding train.
- Notifies the crew of the preceding train that radio blocking has been authorized stating the limits.
- Does not occupy the block limits ahead of the preceding train.

- Is notified by the preceding train that the entire train has cleared a specific block. Location specified must not be beyond block limits of the following train. The following words must be used: "(Train) clear of (block)."
- Does not proceed beyond the last block the preceding train has reported to have cleared.

All instructions between trains must be written, repeated, and acknowledged with "That is correct" before being acted on. These written instructions between the trains must be retained until the end of tour of duty.

**Written Instructions Between Trains:**

"(Preceding Train ID) has cleared (Block) at (Time)." When all available lines on DTC form have been filled in, new DTC authority must be obtained.

Notify the train dispatcher if communication cannot be established between the two trains. If necessary, radio blocking information may be relayed only by the train dispatcher.

The last named point of the following train's authority must not extend beyond the authority of the preceding train.

In the application of Rule 6.4 (Reverse Movements) and Rule 6.6 (Picking Up Crew Member), the movement must not enter the last block reported cleared to the following train.

**Rule Updated Date**

April 20, 2012

[^Top](#)

**16.3: Movement in a Specified Direction**

**Issue Format**

**One or Two Blocks.** The train dispatcher will issue authority and an employee will acknowledge it using the following sample format:

- Train Dispatcher:** "RR 4321 East, with Engineer Jones, you are authorized to proceed Eastward in one block, Anna."
- Crew Member:** "RR 4321 East, with Engineer Jones, I am authorized to proceed Eastward in one block, Anna."
- Train Dispatcher:** "RR 4321 East, that is correct."

**More than Two Blocks.** The train dispatcher will issue authority in more than two blocks using the following sample format:

- Train Dispatcher:** "RR 4321 East, with Engineer Jones, you are authorized to proceed Eastward in three blocks, Anna through Cloy."

**Rule Updated Date**

April 20, 2012

[^Top](#)

### **16.3.1: Leaving the Main Track**

A train authorized to proceed in one direction must inform the train dispatcher when it leaves the main track before reaching the last named point, unless a crew member is left to prevent a following movement from passing.

#### **Rule Updated Date**

April 20, 2012

[^Top](#)

### **16.4: Work and Time**

#### **A. Issue Requirements**

1. Work and time authority may be issued to an employee in charge of on-track equipment when:

- The DTC block is clear.
- The DTC block is occupied by a train and/or employee in charge of on-track equipment that has already been issued work and time. Before joint work and time may be issued, the train dispatcher must first notify the engineer of train or employee in charge of on-track equipment affected that the DTC block will be jointly occupied. All movements must be made at restricted speed within joint work and time limits.

or

- All trains issued Rule 16.3 (Movement in a Specified Direction) have passed the location where the track will be occupied, and the employee receiving the DTC authority is notified that work and time is granted behind such trains.

2. Work and time authority may be issued to a train when:

- The DTC block is clear.
- The DTC block is occupied by a train and/or employee in charge of on-track equipment that has already been issued work and time. Before joint work and time may be issued, the train dispatcher must first notify the engineer of train or employee in charge of on-track equipment affected that the DTC block will be jointly occupied. All movements must be made at restricted speed within joint work and time limits.

or

- All trains issued Rule 16.3 (Movement in a Specified Direction) have passed the location where the track will be occupied and the employee receiving the DTC authority must be notified that work and time is granted behind such trains as prescribed by Rule 16.2 (DTC Authority).

A train or on-track equipment issued work and time may occupy the designated block and move in either direction.

An employee in charge of on-track equipment granted work and time behind a train must not pass train(s) specified.

#### **B. Issue Format**

**One or Two Blocks.** The train dispatcher will issue work and time and an employee will acknowledge it using the following sample format:

**Train Dispatcher:** "RR 4321 East, with Engineer Jones, I am granting you work and time in one block, Anna, until 10:10 AM."

**Crew Member:** "RR 4321 East, with Engineer Jones, I am granted work and time in one block, Anna, until 10:10 AM."

**Train Dispatcher:** "RR 4321 East, that is correct."

**More than Two Blocks.** The train dispatcher will issue authority in more than two blocks using the following sample format:

**Train Dispatcher:** "RR 4321 East, with Engineer Jones, I am granting you work and time in 3 blocks, Anna through Cloy, until 10:10 AM."

**Crew Member:** "RR 4321 East, with Engineer Jones, I am granted work and time in three blocks, Anna through Cloy, until 10:10 AM."

Unless the train and/or employee in charge of on-track equipment receives a time extension, they must clear the block and report "Released" before the time limit expires. The train dispatcher may issue an unspecified time limit by using the words "until released."

**A train dispatcher must not authorize a train to enter a DTC block under Rule 16.3 (Movement in a Specified Direction) until work and time in that block is released.**

### **C. Additional Time**

Trains or the employee in charge of on-track equipment must release work and time before the time granted expires. If the train or employee in charge requires additional time, the authority must be obtained from the train dispatcher before time expires. If a train crew member or employee in charge is unable to contact the train dispatcher, and the time limit expires, authority is extended until the train dispatcher is contacted.

### **Rule Updated Date**

April 20, 2012

[^Top](#)

## **16.5: Changing DTC Authority**

When it becomes necessary to change the authority previously granted to a train, a new authority will be issued in accordance with Rule 16.3 (Movement in a Specified Direction) or Rule 16.4 (Work and Time). After the "(\_\_\_\_\_), that is correct" response is received from the train dispatcher, the authority previously granted becomes void.

The train dispatcher must notify the engineer before withdrawing previously issued DTC authority.

### **Rule Updated Date**

April 20, 2012

[^Top](#)

## 16.6: Releasing DTC Authority

Unless the train dispatcher specifies otherwise, when a train with directional authority clears a DTC block, an employee will immediately release it to the train dispatcher. The train must not re-enter the DTC block it has been released from.

Before a DTC block is released, engineer and conductor must communicate with each other and confirm that their train is clear of DTC block(s) to be released.

### A. Release Format

**One or Two Blocks.** An employee will release a DTC block, and the train dispatcher will acknowledge it using the following sample format:

**Crew Member:** "RR 4321 East, with Engineer Jones, I am releasing one block, Anna."

**Train Dispatcher:** "RR 4321 East, with Engineer Jones, you are releasing one block, Anna."

**Crew Member:** "Train dispatcher, that is correct."

**More than Two Blocks.** An employee will release more than two blocks using the following sample format:

**Crew Member:** "RR 4321 East, with Engineer Jones, I am releasing three blocks, Anna through Cloy."

**A DTC block is not released until the employee releasing the block reports, "Train dispatcher, that is correct."**

### B. Operating in Non-Signaled or DoubleTrackTerritory

In non-signaled or double track territory, a train without a crew member on the rear of the train may release a DTC block only when the complete train is clear of the limits, which is determined by one of the following:

1. The rear of the train has an operating rear-end telemetry device, and the air pressure on the head-end device indicates brake pipe continuity.
2. An employee verifies that a marker is on the rear of the train.
3. A crew member can observe the rear car of the train on which the marker has been placed.
4. A trackside warning detector transmits an axle count for the train, and the axle count duplicates the axle count transmitted by the previous trackside warning detector.

In addition, a train clearing in a siding or other track must comply with requirements outlined in Rule 8.3 (Main Track Switches) before reporting clear of the limits.

### Rule Updated Date

April 20, 2012



[^Top](#)

## **16.7: Communication Failure**

If communication fails, a third party may relay the authority to enter and/or release a DTC block as follows:

- The train dispatcher must transmit the DTC authority to the third party.
- The third party must repeat it back to the train dispatcher.
- If correct, the train dispatcher will respond, "(Third Party Identification), that is correct for relay," which authorizes the third party to transmit the DTC authority to a crew member.
- The crew member receiving the DTC authority must repeat it back to the third party.
- If correct, the third party will respond, "(\_\_\_\_\_), that is correct" and inform the train dispatcher that DTC authority has been relayed correctly.

### **Rule Updated Date**

April 20, 2012

[^Top](#)

## [Union Pacific Rules](#)

### UPRR - General Code of Operating Rules

## **17.0: RULES APPLICABLE ONLY IN AUTOMATIC TRAIN CONTROL (ATC) TERRITORY**

- [17.1: Automatic Train Control Territory](#)
- [17.2: Taking Charge](#)
- [17.3: Cut In and Cut Out Requirements](#)
- [17.4: Departure Test Requirements](#)
- [17.4.1: Departure Test Reporting](#)
- [17.4.2: ATC Automatic Cut-in Circuit](#)
- [17.5: High Speed Setting](#)
- [17.5.1: Over 40 MPH](#)
- [17.5.2: Under 40 MPH](#)
- [17.5.3: Restricting Cab Signal](#)
- [17.6: Conforming with Block Signals](#)
- [17.6.1: Approaching Diverging Route](#)
- [17.7: ATC Failure/Cut-out Enroute](#)
- [17.7.1: Speed Indicator in ATC](#)
- [17.7.2: ATC Motion Light](#)
- [17.7.3: Audible Indicator](#)
- [17.8: Improper Display](#)

### **17.1: Automatic Train Control Territory**

ATC territory is specified in special instructions. An engine must not be operated in ATC territory if it is not equipped with an operable ATC system unless otherwise authorized by special instructions or the train dispatcher.

#### **Rule Updated Date**

April 7, 2010

[^Top](#)

### **17.2: Taking Charge**

When taking charge of an engine equipped with ATC in ATC territory or entering such territory, engineers must know that:

1. The ATC system is cut in and sealed or locked on engines equipped.
2. The following devices are sealed (on engines equipped) with a mechanical seal:
  - Speed indicator case.

- Speed indicator cables.
- High speed whistle cutout cock.

### **Rule Updated Date**

April 7, 2010

[^Top](#)

## **17.3: Cut In and Cut Out Requirements**

The ATC system, in part or in its entirety, must not be cut out in ATC territory unless:

- Train dispatcher grants permission.

or

- Failure of the ATC system prevents train movement at restricted speed (unable to recover the air) and crew is unable to immediately contact the train dispatcher. The train dispatcher must be notified as soon as practical. Notification must include if cab signals are operative.

The train dispatcher may grant permission to a crew member to cut out the ATC system when:

- It has failed. Before granting permission to the crew to cut out the ATC the train dispatcher must determine if the cab signals are operative.

or

- Required for movements against the current of traffic at speeds above restricted speed.

### **A. Cutting In ATC**

To cut in ATC:

1. Turn on the ATC system.
2. Acknowledge when the acknowledging horn sounds.
3. Cut in the ATC actuator and seal or lock.

### **B. Cutting Out ATC**

To cut out ATC:

1. Break the seal or unlock and cut out the ATC actuator.
2. Turn off the power to the ATC system.

If ATC is cut out due to failure enroute, at the next stop the engineer must cut in the ATC to determine if it is again operable. Train dispatcher must be notified if ATC is again operative or continues to fail and if cab signals are operative if previously cut out.

## **Rule Updated Date**

April 7, 2010

[^Top](#)

## **17.4: Departure Test Requirements**

A departure test is required:

- Before entering ATC territory.  
or
- When the ATC is cut in after being cut out enroute within ATC territory.

### **A. Energized Test Loop**

While the engine is standing on energized test loop:

1. The cab signal should display a Clear aspect.
2. When the test loop is de-energized or when the engine is moved off of the test loop, the aspect will change to a Restricting and the acknowledging horn will sound. Do not acknowledge the horn and do not move the brake valve handle.
3. A penalty brake application should occur within 8 seconds.
4. Recover the air.
5. When the horn sounds again, acknowledge to prevent a penalty brake application.

Note: To recover the air after an ATC penalty brake application, acknowledge the horn or alarm and move the brake valve handle to SUPPRESSION until the PCS light has gone out. The brakes may then be released.

Receivers on Both Ends: When an engine has ATC receivers on both ends and is standing on energized track, the cab signal should display Clear.

1. Place the reverser in Reverse position. The cab signal will change to Restricting and the acknowledging horn will sound.
2. Do not acknowledge the horn and do not move the brake valve handle. A penalty brake application should occur within 8 seconds.
3. Recover the air.
4. When the horn sounds again, acknowledge to prevent brake application.

### **B. De-energized Track**

When engine is standing on de-energized track:

1. Release the brakes, but do not acknowledge the acknowledging horn.
2. A penalty brake application should occur within 8 seconds.
3. Recover the air.
4. When the horn sounds again, acknowledge to prevent a penalty brake application.

## **Rule Updated Date**

July 11, 2023

## System Special Instructions

Effective Date: July 11, 2023

[^Top](#)

### 17.4.1: Departure Test Reporting

Records of ATC and ATS tests:

- Must be retained for 92 days.
  - Must be placed in the engine cab.
1. When Mechanical Department employees perform the test:
    - One part of the form must be retained at the test location for 92 days.
    - The other must be placed in the inspection holder in the engine cab.
  2. At points where engineers are required to perform ATC or ATS departure tests, engineers must complete the form, place it in the inspection holder of the engine, and notify the train dispatcher. Crew members are not to remove this form unless specifically instructed to do so.
  3. The train dispatcher, unless instructed otherwise, must record the date, time, location, engine number and name of the engineer.

#### Rule Updated Date

April 7, 2010

[^Top](#)

### 17.4.2: ATC Automatic Cut-in Circuit

Rule has been deleted.

#### Rule Updated Date

July 11, 2023

## System Special Instructions

Effective Date: July 11, 2023

[^Top](#)

### 17.5: High Speed Setting

When a cab signal displays a Clear aspect and the train speed exceeds the high speed setting, a high-speed whistle will sound continuously. This will require a SUPPRESSION brake application within 6 seconds to prevent a penalty brake application.

**Rule Updated Date**

April 7, 2010

[^Top](#)

**17.5.1: Over 40 MPH**

The high speed whistle will sound when the speed is more than 40 MPH when the cab signal changes to a Restricting aspect.

1. Move the brake valve handle to SUPPRESSION within 6 seconds to prevent a penalty brake application.
2. When speed is reduced to less than 40 MPH, the high speed whistle will stop and the acknowledging horn will sound.
3. Acknowledge this horn. If the cab signal continues to display Restricting, speed must immediately be reduced to restricted speed.

If restricted speed is not reached within 70 seconds after the acknowledging horn was acknowledged, a penalty brake application will occur unless the brake valve handle is in SUPPRESSION.

**Rule Updated Date**

April 7, 2010

[^Top](#)

**17.5.2: Under 40 MPH**

The acknowledging horn will sound if the cab signal changes from Clear to Restricting when the speed is under 40 MPH.

1. Acknowledge the horn within 6 seconds to prevent a penalty brake application.
2. If the cab signal continues to display Restricting, train speed must immediately be reduced to restricted speed.

If restricted speed is not reached within 70 seconds after the acknowledging horn was acknowledged, a penalty brake application will occur unless the brake valve handle is in SUPPRESSION.

**Rule Updated Date**

April 7, 2010

[^Top](#)

**17.5.3: Restricting Cab Signal**

When cab signal changes from a Clear to a Restricting aspect, trains exceeding Restricted Speed must immediately reduce to Restricted Speed. While the cab signal continuously displays a Restricting aspect, the acknowledging horn will sound to alert the crew members of the restriction. When the speed is approaching the restricting over speed setting, the low speed alarm will sound to alert crew members that speed must be reduced.

**Rule Updated Date**

April 7, 2010

[^Top](#)

## **17.6: Conforming with Block Signals**

Cab signal indications do not supersede the indication displayed on block and interlocking signals. The most restrictive block or cab signal indication must be complied with. However, when the cab signal changes from Restricting to Clear after having passed the block or interlocking signal, the train may immediately comply with the cab signal indication.

Except where cab signals are capable of displaying diverging route aspects, when initiating movement or when the cab signal changes from Restricting to Clear after the engine passes a signal that governs the approach to a diverging route, the train must approach the next signal at the speed prescribed for the most restrictive route at that location until the next signal is visible.

Note: When the cab signal cycles from Clear to Restricting and immediately back to Clear, the train may continue at normal speed.

### **Rule Updated Date**

April 7, 2010

[^Top](#)

### **17.6.1: Approaching Diverging Route**

When the cab signal changes from Restricting to Clear after the engine passes a signal displaying an Approach or a more restricting indication and the next signal can display an indication for a diverging route, the train must approach the next signal at the speed prescribed for the most restrictive route at that location. However, if the signal is seen to display an indication for a more favorable route, the speed for that route governs.

### **Rule Updated Date**

April 7, 2010

[^Top](#)

## **17.7: ATC Failure/Cut-out Enroute**

When any part of the ATC system is cut-out enroute:

1. Before an absolute block is established in advance of the train:
  - If cab signals are operative or movement will be entirely in a continuous block signal territory, proceed not exceeding 40 MPH.
  - or
  - If cab signals are not operative and movement is outside continuous block signal territory, proceed at restricted speed.
2. After an absolute block is established in advance of a train:

- If cab signals are operative or movement will be entirely in continuous block signal territory, proceed in accordance with signal indications not exceeding 79 MPH.
- If cab signals are not operative and movement is outside continuous block signal territory:
  - Passenger trains may proceed not exceeding 59 MPH.
  - Freight trains may proceed not exceeding 49 MPH.

3. Before an absolute block in advance of movement is established in ATC territory the train dispatcher must determine if:

- The cab signals are operative
- The absolute block in advance of movement will be entirely in territory with continuous fixed block signals.
  - a If the cab signals are operative or the absolute block in advance of movement will be entirely in continuous block signal territory, the train dispatcher may establish an absolute block in advance of movement as provided by Rule 11.1 (Establishing an Absolute Block). Rule 11.2 (Signal Indications with Absolute Block) applies. If the cab signal changes to Restricting the train must stop.
  - b If the cab signals are inoperative and any part of the absolute block in advance of movement will be outside continuous block signal territory, the train dispatcher must not establish an absolute block in advance of movement until it is determined that no trains or engines:
    - Occupy the limits ahead of the train being given the absolute block in advance of movement.
    - Will occupy the limits ahead of the train being given the absolute block in advance of movement.
  - c Rule 9.15 (Track Permit) or Rule 10.3 (Track and Time) establishes an absolute block when not issued joint.

**Note:** Continuous block signal territory is designated on the subdivision page where ATC is in effect.

**Rule Updated Date**

April 1, 2015

[^Top](#)

**17.7.1: Speed Indicator in ATC**

An inoperative or inaccurate speed indicator, as prescribed by Rule 1.39 (Accuracy of Speed Indicator) is considered an ATC failure. Rule 17.7 (ATC Failure/Cut Out Enroute ) applies.

**Rule Updated Date**

April 7, 2010

[^Top](#)

**17.7.2: ATC Motion Light**

If the motion light is not on when the speed is 6 MPH or above, proceed in accordance with the cab signal indication but not to exceed 40 MPH. Rule 17.7 (ATC Failure/Cut Out Enroute) applies.



**Rule Updated Date**

April 7, 2010

[^Top](#)

**17.7.3: Audible Indicator**

If the audible indicator does not sound when the cab signal changes to a more restrictive indication or continues to sound when the cab signal change is acknowledged, it is considered an ATC failure. Rule 17.7 (ATC Failure/Cut Out Enroute) applies.

**Rule Updated Date**

April 7, 2010

[^Top](#)

**17.8: Improper Display**

If a cab signal displays Clear when it should display Restricting due to an open switch, occupied block, or other condition, the train must:

- Stop and warn other trains by radio of exact location and status of train.
- Contact the train dispatcher and be governed by his instructions. If the train dispatcher gives permission to proceed, the train must proceed at restricted speed until the train dispatcher establishes an absolute block in advance of movement.

**Rule Updated Date**

July 11, 2023

**System Special Instructions**

Effective Date: July 11, 2023

[^Top](#)

## [Union Pacific Rules](#)

### UPRR - General Code of Operating Rules

# **18.0: RULES APPLICABLE ONLY IN POSITIVE TRAIN CONTROL (PTC) TERRITORY**

## **Chapter Introduction**

### **18.0: RULES APPLICABLE ONLY IN POSITIVE TRAIN CONTROL (PTC) TERRITORY**

- [18.1: Positive Train Control Territory](#)
- [18.2: Taking Charge of PTC Equipped Trains](#)
- [18.3: Broken or Missing Seals](#)
- [18.4: PTC Cut Out](#)
- [18.5: PTC Trip Completion](#)
- [18.6: Consist Data](#)
- [18.7: Comparison of PTC Display Information](#)
- [18.8: PTC System Inputs and Prompts](#)
- [18.9: Use of Restricted Mode](#)
- [18.10: Working with Helper Units](#)
- [18.11: Electronic Delivery of Mandatory Directives](#)
- [18.12: Movements with Inoperative PTC System](#)
- [18.13: Movements Without PTC](#)

## **18.1: Positive Train Control Territory**

PTC territory is specified in special instructions. A train must not be operated in PTC territory if the controlling locomotive is not equipped with an operable PTC system unless otherwise authorized by rule, special instructions, or the train dispatcher.

### **Rule Updated Date**

December 29, 2017

[^Top](#)

## **18.2: Taking Charge of PTC Equipped Trains**

When taking charge of a train, the engineer must confirm the following:

1. The PTC circuit breaker and cut out switches are in the appropriate position.
2. The PTC system on the controlling locomotive is initialized, with UP selected as the operating railroad, by the engineer who will operate the train and in the DISENGAGED or ACTIVE state.

3. Departure test is performed at the train's initial terminal, when the controlling locomotive is changed, or when prompted by the PTC system.

Before departing the train's initial terminal or a Designated PTC Repair Location, PTC must be operative, initialized, and in the ACTIVE or DISENGAGED state on the controlling locomotive.

When the controlling locomotive's PTC system becomes inoperative enroute (including initialization failure at other than the train's initial terminal or Designated PTC Repair Location), be governed by Rule 18.12 (Movements with Inoperative PTC System).

Application:

Initialization failure with railroads other than UPRR is not considered an initialization failure

#### **Rule Updated Date**

July 11, 2023

#### **System Special Instructions**

Effective Date: May 10, 2022

#### **General Order**

Effective Date: July 11, 2023

[^Top](#)

### **18.3: Broken or Missing Seals**

Unless authorized, do not break the protective seals on PTC devices. Report broken or missing PTC seals to the designated authority.

#### **Rule Updated Date**

December 29, 2017

[^Top](#)

### **18.4: PTC Cut Out**

The PTC system may only be cut out or disabled when authorized by rule or train dispatcher.

#### **Rule Updated Date**

December 29, 2017

[^Top](#)

## **18.5: PTC Trip Completion**

At the completion of the trip, the engineer must log out of PTC.

### **Rule Updated Date**

December 28, 2017

[^Top](#)

## **18.6: Consist Data**

PTC consist data must reflect accurate train make-up. The PTC consist data must be updated after any work events.

### **Rule Updated Date**

December 29, 2017

### **System Special Instructions**

Effective Date: December 29, 2017

[^Top](#)

## **18.7: Comparison of PTC Display Information**

Before departing, crew members on the controlling locomotive must compare information such as track bulletins, restrictions, and authorities shown on the PTC display with those in their possession.

When a crew member receives a mandatory directive or restriction verbally, it must then be verified with the PTC display.

When the PTC display does not conform with a wayside signal indication, maximum authorized speed, mandatory directive, timetable, or special instruction, be governed by the most restrictive.

Any discrepancies must be reported to the train dispatcher.

### **Rule Updated Date**

July 11, 2023

### **System Special Instructions**

Effective Date: July 11, 2023

[^Top](#)

## **18.8: PTC System Inputs and Prompts**

Inputs and responses to prompts must be accurate and timely to prevent an unnecessary PTC enforcement or delay. The engineer must operate the train in response to a PTC prompt to prevent a penalty brake application, consistent with good train handling. If improper input or response to a prompt is made, it must not be acted upon until corrected or resolved.

**Rule Updated Date**

December 29, 2017

[^Top](#)

## **18.9: Use of Restricted Mode**

Restricted Mode must be turned on before performing work events such as:

- Switching.
- Making pickups and/or setouts, etc.
- During work train operations (loading, unloading, etc.) while under the supervision of the MW employee in charge.

Restricted Mode must be turned off after work event has been completed and when moving between locations.

**Rule Updated Date**

May 10, 2022

**System Special Instructions**

Effective Date: May 10, 2022

[^Top](#)

## **18.10: Working with Helper Units**

A. Helpers added to head end of the train:

- Perform soft cut out of the PTC system on lead engine of the train after helper unit(s) are added.
- Initialize PTC on the lead helper locomotive prior to movement.
- PTC must be cut in after helpers are removed and prior to movement.

B. No changes are required to the PTC system on the lead engine when helpers are added to the rear end of the train.

**Rule Updated Date**

December 29, 2017

**System Special Instructions**

Effective Date: December 29, 2017

[^Top](#)

## **18.11: Electronic Delivery of Mandatory Directives**

Mandatory directives may be transmitted by the dispatcher to the PTC on-board system.

Employee will copy the mandatory directive using the format outlined in the operating rules. The conductor and the engineer must each have a copy of the mandatory directive issued to their train, and each crew member must read and understand it.

Before acting upon a transmitted authority, the crew must verify the authority number, designated limits, and any conditions of authority with the train dispatcher. The "OK" time will be given when the authority is issued.

Authorities that restrict a previously issued authority must not be transmitted until the train crew has confirmed the change to authority can be complied with.

When restrictions are transmitted the crew must verify the restriction is within the train's scheduled route, and upon correct verification, the dispatcher will give the OK time and initials. When restriction is not within the train's scheduled route, verbal confirmation with the dispatcher is not required.

### **Rule Updated Date**

October 19, 2023

### **System Special Instructions**

Effective Date: January 7, 2019

### **General Order**

Effective Date: October 19, 2023

[^Top](#)

## **18.12: Movements with Inoperative PTC System**

Immediately notify the train dispatcher when the controlling locomotive's PTC system fails to initialize or becomes inoperative enroute, except when operating where PTC is suspended by Mandatory Directive.

When the PTC System on the controlling locomotive becomes inoperative while enroute, or when movement of a locomotive with inoperative PTC is otherwise authorized by the Train Dispatcher, movement may continue to the next Designated PTC Repair Location.

Unless further restricted, the following maximum speeds will govern:

<b>In non-signaled territory (including operating within signal suspension limits), or when operating against the current of traffic in Rule 9.14 (Movement with the Current of Traffic) territory:</b>
---

Trains transporting one or more loaded cars containing TIH/PIH	30 MPH
All other trains	40 MPH
<b>In signaled territory:</b>	
Freight trains transporting one or more loaded cars containing TIH/PIH	40 MPH
Freight trains not transporting loaded cars containing TIH/PIH	49 MPH
Passenger trains	59 MPH

#### Rule Updated Date

July 11, 2023

#### System Special Instructions

Effective Date: May 10, 2022

#### General Order

Effective Date: July 11, 2023

[^Top](#)

### 18.13: Movements Without PTC

Trains engaged in freight switching, transfer train service (including yard, local, and industrial), hostling, work train service, or the assembling or disassembling of trains, may operate in PTC territory without the controlling locomotive being PTC equipped or initialized, provided:

1. The dispatcher authorizes the movement to be made without operational PTC.
2. The movement originates in a yard, or within 20 miles of a yard with the yard as the final destination point.
3. The movement does not travel in excess of 20 miles from the point of entry onto PTC-equipped main track. If main track movement in PTC territory will be made on more than one railroad, combined movement on all railroads must not exceed 20 miles.
4. The movement must not exceed Restricted Speed unless all three of the following conditions are met:
  - No other train or locomotive is operating without operational PTC within the same authorized limits.\*
  - No Form B Track Bulletin is in effect within the same authorized limits.\*
  - A Class I, II, or Transfer Train brake test has been performed in which case the movement must not exceed 30 MPH.

\* Application: Same authorized limits are a segment of track:

- Between consecutive controlled absolute signals.
- Listed on a mandatory directive.

#### Rule Updated Date

July 22, 2022

**System Special Instructions**

Effective Date: July 11, 2023

[^Top](#)



[Union Pacific Rules](#)

[UPRR - General Code of Operating Rules](#)

**GLOSSARY: Glossary**

- [19.GL: GENERAL CODE OF OPERATING RULES GLOSSARY](#)

**19.GL: GENERAL CODE OF OPERATING RULES GLOSSARY**

**Abbreviations**

Use only the following abbreviations:

**ABS** Automatic Block Signal System

**ACS** Automatic Cab Signal System

**AMTK** Amtrak

**ATC** Automatic Train Control

**ATS** Automatic Train Stop

**AUTH** Authority

**BO** Bad Order

**BRN** Branch

**BRT** Block Register Territory

**C** Center

**C & E** Conductor and Engineer

**COFC** Container on Flat Car

**CONDR** Conductor

**CP** Control Point

**CTC** Centralized Traffic Control

**DCS** Dual Control Switch

**DISPR** Dispatcher

**DIST** District

**DIV** Division

**DT** Double Track

**DTC** Direct Traffic Control

**E** East

**ENG** Engine

**ENGR** Engineer

**ESS** East Siding Switch

**EWD** Eastward

**FRT** Freight

**HER** Head End Restriction

**IM** Intermodal

**JCT** Junction

**MAX** Maximum

**MMT** Multiple Main Track  
**MP** Mile Post  
**MPH** Miles Per Hour  
**MT** Main Track  
**MW** Maintenance of Way  
**N** North  
**NO** Number  
**NSS** North Siding Switch  
**NWD** Northward  
**OCT** Other Controlled Track  
**OK** Correct  
**OOS** Out of Service  
**OPR** Operator  
**ORIG** Originating  
**OCT** Other Controlled Track  
**PIH** Poisonous Inhalation Hazard  
**PSGR** Passenger  
**PTC** Positive Train Control  
**RC** Radio Channel  
**RCO** Remote Control Operator  
**RCZ** Remote Control Zone  
**RECD** Received  
**RE** Region  
**S** South  
**SDG** Siding  
**SI** Special Instructions  
**SSI** System Special Instructions  
**SSS** South Siding Switch  
**SUB** Subdivision  
**SUBDIV** Subdivision  
**SUPT** Superintendent  
**SW** Switch  
**SWD** Southward  
**TIH** Toxic Inhalation Hazard  
**TOFC** Trailer on Flat Car  
**TRK** Track  
**TRN** Train  
**TWC** Track Warrant Control  
**W** West  
**WSS** West Siding Switch  
**WWD** Westward  
**XO** Crossover  
**YD** Yard  
**YL** Yard Limits

## **YM** Yardmaster

Use the normal abbreviations for names of months.

## **ABS**

*See Automatic Block Signal System.*

## **Absolute Block**

A length of track that no train is permitted to enter while the track is occupied by another train.

## **Absolute Signal**

A block or interlocking signal without a number plate, or designated by an A marker.

## **ACS**

*See Automatic Cab Signal System.*

## **Adjacent Track**

Parallel tracks that are not separated by a single lane roadway or similar distance are considered adjacent tracks.

**Note:** This definition only applies when determining if Track Breach Protection is required.

## **Articulated**

Permanently connected multiple unit cars that share a common truck.

## **ATC actuator**

An ATC brake applying apparatus.

## **ATS**

*See Automatic Train Stop System.*

## **Automatic Block Signal System (ABS)**

A series of consecutive blocks governed by block signals, cab signals, or both. The signals are activated by a train or by certain conditions that affect the block use.

## **Automatic Cab Signal System (ACS)**

A system that allows cab signals and the cab warning whistle to operate automatically.

**Automatic Train Control (ATC)**A system to enforce compliance with cab and wayside signal indications. If the train exceeds a predetermined speed for a given signal indication and speed is not reduced at a sufficient rate, brakes are automatically applied.

## **Automatic Train Stop System (ATS)**

A system activated by wayside inductors positioned to apply the brakes automatically until the train stops.

## **Block**

A length of track:

- Between consecutive block signals
- Between a block signal and the end of block system limits
- or
- In ATC limits, the use of which is governed by cab signals and/or block signals.

**Block Register Territory (BRT)**

A method of operation in non-signaled territory where trains, men, and equipment are authorized to occupy the main track in limits designated by the timetable.

**Block Signal**

A fixed signal at the entrance of a block that governs trains entering and using that block.

**Block System**

A block or series of consecutive blocks within ABS, ACS, CTC, or interlocking limits.

**Breach**

To enter an area between two adjacent tracks.

**BRT**

*See Block Register Territory.*

**Cab Red Zone**

A "Cab Red Zone" (CRZ) exists during critical times or when multiple tasks are occurring. During a Cab Red Zone, an environment must be created in the locomotive control compartment that focuses exclusively on controlling the train, verbally communicating restrictions, and proper application of the rules.

**Cab Signal**

A signal in the engineer's compartment or cab that indicates a condition affecting train movement. Cab signals are used with interlocking or block signals or without block signals.

**Cars**

Railroad cars.

**Centralized Traffic Control (CTC)**

A block system that uses block signal indications to authorize train movements.

**Clearance Point**

The location closest to a switch where it is safe for equipment, and a person riding the side of equipment unless prohibited, to pass equipment on an adjacent track. Clearance Point location may be identified by a clearance cone and/or painting of rails and ties.

**Conductor**

Crew member in charge of train or yard crew.

**Control Operator**

Employee assigned to operate a CTC or interlocking control machine or authorized to grant track permits.

**Control Point**

The location of absolute signals controlled by a control operator.

**Controlled Siding**

A siding within CTC or interlocking limits where a signal indication authorizes the siding's use.

**Controlled Signal**

An absolute signal controlled by a control operator.

**Crew Member**

Conductors, assistant conductors, brakemen, engineers, remote control operators, yard engine foremen, switchmen, and yard helpers.

**Crossings at Grade**

Crossings that intersect at the same level.

**Crossover**

A combination of two switches that connect two adjacent tracks, normally used for crossover movements. Crossover speed is restricted to the lowest connected turnout speed.

**CTC**

*See Centralized Traffic Control.*

**Current of Traffic**

The movement of trains in one direction on a main track, as specified by the rules.

**Direct Traffic Control (DTC)**

A DTC block or a series of DTC blocks where the train dispatcher authorizes track occupancy.

**Distant Signal**

A fixed signal outside a block system that governs the approach to a block signal, interlocking signal, or switch point indicator. A distant signal does not indicate conditions that affect track use between the distant signal and block or interlocking signals or between the distant signal and switch point indicator. A distant signal is identified by a D.

**Double Track**

Two main tracks where the current of traffic on one track is in a specified direction and in the opposite direction on the other.

**Dual Control Switch**

A power-operated switch, moveable point frog, or derail that can also be operated by hand.

**DTC**

*See Direct Traffic Control.*

**DTC Block**

A length of main track specified by name. DTC block name and limits are identified by wayside signs reading, Begin (name) Block and End (name) Block and by mile post location in the timetable.

**Electric Switch Lock**

An electrically controlled lock that restricts the use of a hand-operated switch or derail.

**Electronic Device**

An electronic or electrical device used to conduct oral, written, or visual communication; place or receive a telephone call; send or read an electronic mail message or text message; look at pictures; read a book or other written material; play a game; navigate the Internet; navigate the physical world; play, view, or listen to a video; play, view or listen to a television broadcast; play or listen to music; execute a computational function; or, perform any other function that is not necessary for the health or safety of the person and that entails the risk of distracting the employee or another employee from a safety related task.

**Engine**

A unit propelled by any form of energy or more than one of these units operated from a single control. Engines are used in train or yard service. Rules that apply to engines also apply to cab control cars.

**Engineer**

Also includes student engineers, firemen, hostlers, and remote control operators.

**Equipment**

Railroad equipment.

**Equipment Fouling a Track**

The end of rolling equipment or on-track maintenance of way equipment left between the clearance point and the switch points leading to the track on which the equipment is standing.

**Fixed Signal**

A signal that is fixed to a location permanently and that indicates a condition affecting train movement.

**Flagman**

Any employee providing flag protection as outlined in Rule 6.19 (Flag Protection) and for other purposes as outlined in the rules.

**Foreman**

Employee in charge of work.

**Gravity Switch**

A switching process using gravity to reposition cars on the opposite end of a locomotive, without using locomotive to start movement of cars. See Rule 7.7.1.

**Hard Cut In (PTC)**

A state of the PTC system when PTC cut out switches are placed in the cut in position.

**Hard Cut Out (PTC)**

A state of the PTC system when PTC cut out switches are placed in the cut out position.

**Humping Cars**

Allowing cars to roll into remotely controlled sorting tracks under their own momentum during cresting operations at a hump yard. After uncoupling, the speed of the movement is controlled through the use of retarders.

**Interlocking**

Signal appliances that are interconnected so that each of their movements follows the other in a proper sequence. Interlockings may be operated manually or automatically.

**Interlocking Limits**

The tracks between outer opposing absolute signals of an interlocking.

**Interlocking Signals**

The fixed signals of an interlocking that govern trains using interlocking limits.

**Jump Frog**

A main track frog designed for use with low traffic turnouts. The main track side is made up of an unbroken rail and the turnout side carries the wheel over the main track rail by supporting the flange of the wheel.

**Kicking Cars**

To shove a car a short distance and uncouple it in motion.

**Main Track**

A track extending through yards and between stations that must not be occupied without authority or protection.

**Men or Equipment**

A term referring to Engineering Department employees and their related equipment.

**Multiple Main Tracks**

Two or more main tracks that are used according to the timetable.

**Non-enforcement State (PTC)**

A state when the PTC system is cut out, failed, degraded, disengaged, or experiencing other unenforceable conditions.

**Other Controlled Track (OCT)**

A segment of track (not main track or siding) between Control Points that is governed by GCOR Chapter 10 (CTC) rules. Locations of OCT are listed in the timetable.

**Pilot**

An employee assigned to a train to assist an engineer or conductor who is unfamiliar with the rules or the portion of railroad the train will operate on.

**Positive Train Control (PTC)**

A safety overlay system designed to monitor train movement and designed to prevent train to train collisions, over speed violations, movement into established work zone limits without permission, and movement over an improperly lined main track switch.

**Proceed Indication**

Any block signal indication that allows a train to proceed without stopping.

**PTC Equipped**

A locomotive equipped with an operable PTC system.

**Radio**

As used in these rules it also applies to wireless communication devices when used in railroad operations.

**Radio Blocking**

A method to establish an absolute block for a following train in non-signaled territory by direct communication with a preceding train.

**Radio Speed Restriction**

A speed restriction received from the train dispatcher while enroute.

**Railroad Operating Employee**

An individual who is engaged in or connected with the movement of a train including a hostler, a train employee providing commuter or inter-city rail passenger transportation, or is subject to hours of service governing trains service employees.

**RCO**

See Remote Control Operator

**RCZ**

See Remote Control Zone

**Remote Control Operator (RCO)**

An employee who may operate an engine with or without cars by means of a remote control transmitter.

**Remote Control Transmitter**

A device that gives the remote control operator control of a remote control engine.

**Remote Control Zone (RCZ)**

A portion of track(s) within definite limits designated in the timetable special instructions.

**Restricted Limits**

A portion of main track designated by restricted limits signs and timetable special instructions or a track bulletin.

**Restricted Mode**

A mode where the only function provided by PTC is enforcement of the maximum speed indicated on the PTC display.

**Reverse Movement**

A movement opposite the authorized direction.

**Siding**

A track connected to the main track and used for meeting or passing trains. Location of sidings are shown in the timetable.

**Signal Aspect**

The appearance of a fixed or cab signal.

**Signal Indication**

The action required by the signal aspect.

**Single Track**

A main track where trains are operated in both directions.

**Soft Cut In (PTC)**

A state of the PTC system resulting from selection of the cut in key on the PTC display.

**Soft Cut Out (PTC)**

A state of the PTC system resulting from selection of the cut out key on the PTC display.

**Special Instructions**

Instructions contained in the timetable or other publication.

**Spring Switch**

A switch with a spring mechanism that returns the switch points to the original position after they are trailed through.



**Spur Track**

A track connected to another track at only one end, also referred to as a stub track.

**Station**

A place designated by name in the timetable station column.

**Stowed**

When items such as electronic devices, literature, etc. are required to be stowed, the items are not properly stowed until they are placed out of sight in the employee's grip, luggage, back pack, etc. Personal electronic devices must be turned off and are not considered stowed when placed in pockets or device holders.

**Switch Point Indicator**

A light type indicator used during movement over certain switches to show that switch points fit properly.

**Switch Providing Direct Access**

A switch that if used by rolling equipment could permit the rolling equipment to enter the track and couple to equipment.

**Timetable**

A publication with instructions on train, engine, or equipment movement. It also contains other essential information.

**Track Bulletin**

A notice of conditions affecting train movement. It may also authorize movement against the current of traffic where Rule 9.14 (Movement with the Current of Traffic) is in effect.

**Track Occupancy Indicator**

An indicator that tells whether a length of track is occupied or not.

**Trackside Warning Detector**

A device that indicates conditions such as overheated journals, dragging equipment, excess dimensions, shifted loads, high water, or slides.

**Track Warrant Control (TWC)**

A method to authorize train movements or protect men or machines on a main track within specified limits in a territory designated by the timetable.

**Train**

One or more engines coupled, with or without cars, displaying a marker, and authorized to operate on a main track. A term that when used in connection with speed restrictions, flag protection, and the observance of all signals and signal rules also applies to engines.

**Train Coordination**

Working limits established by a roadway worker through the use of a train's authority on a main track or other track where specific authority is required from a control operator or train dispatcher.

**Train Dispatcher**

Employee assigned to operate a CTC or interlocking machine, transmit or deliver orders affecting train movements, and supervise train movements and any employees connected with that movement, including control operators.

**Train ID**

Trains will be identified by initials and engine number, adding the direction when required. When an engine consists of more than one unit or when two or more engines are coupled, the number of one unit only will be illuminated as the identifying

number. The identifying number will be the number of the lead unit, unless changing direction during a trip or tour of duty when that unit is no longer the lead unit.

**TWC**

*See Track Warrant Control.*

**Variable Switch**

A switch identified by a V or a bowl painted yellow. When traileed through, the switch points remain lined in the position they were forced.

**Whistle Quiet Zone**

A designated portion of track, that includes road crossing(s) at grade where whistle signal (7) is not regularly sounded.

**Working Limits**

A segment of track within definite boundaries on which movements may be made only as permitted by the employee in charge. Boundaries may be established using mile posts, station signs, timetable locations, or clearly identifiable points.

**Yard**

A system of tracks, other than main tracks and sidings, used for making up trains, storing cars, and other purposes.

**Yard Access Crossing**

A grade crossing that is located within the physical confines of a railroad yard and is either:

- Open to unrestricted public access;
- or
- Open to persons other than railroad employees going about their normal duties, e.g., business guests or family members.

**Yard Limits**

A portion of main track designated by yard limit signs and timetable special instructions or a track bulletin.

**Rule Updated Date**

July 11, 2023

**System Special Instructions**

Effective Date: July 11, 2023

[^Top](#)